

POSTMASTER:
PLEASE EXPEDITE DELIVERY
DATED MATERIAL

ADDRESS CORRECTION REQUESTED

BULK RATE
U.S. POSTAGE
PAID
COLTON, OR 97017
PERMIT #51

The SINCLAIR Computer Technology Magazine

SEPT/OCT '88
VOL. 4 NO. 6

TIME

designs

MAGAZINE



A Christmas Wish for _____

SPECTERM-64(TS-4.1)

300/1200 Terminal Software for T/S2068
On JLO, AERCO, Larken disk or tape.
Only \$25.00 + \$2.50 S&H

ALSO

Z-SI/O Bare Boards

RS-232c Serial Interface for T/S2068
With FREE 2050 card
Only \$24.50 + \$2.50 S&H

OR BOTH FOR ONLY
\$50.00 inc. S&H

(OUTSIDE 48 CONTIGUOUS STATES, \$6.50 S&H)

LARKEN Disk Hardware:

LARKEN Disk System for T/S2068

Includes LARKEN Floppy Disk Interface, LKDOS (v.3)
Cartridge, Operating Manual and LKDOS Utilities' Disk.
Only \$120.00 + \$5.00 S&H

LKDOS Cartridge for JLO

Specially configured LKDOS (v.3) Cartridge that
works with your JLO SAFE Disk hardware. Includes
Operating Manual and LKDOS Utilities' Disk.
Only \$65.00 + \$3.50 S&H

LARKEN Ramdisk for T/S2068

No RAM chips are included. You can add up
to 256K to this Nonvolatile Ramdisk. Easy to use
as a floppy disk with LKDOS.
Only \$60.00 + \$3.50 S&H

Tandon TM101-4 Quad Disk Drives

These disk drives are brand new in factory
sealed cartons. They are double sided,
double density, 96 tpi (quad), full height
drives. They are compatible with JLO,
LKDOS, AERCO and QL disk systems.

\$45.00 + \$5.00 S&H

Buy 2, Get FREE Drive Cable!
Buy 3, Get 4th for Half Price!
Buy 4, Get One Disk Drive FREE!

Cable (2dr)..\$12.50+\$2.50 S&H

Hayes Compatible MODEMS

Avatex 2400 (3/12/2400)....\$179
For CP/M, IBM and other systems.

Avatex 1200hc (300/1200).....\$99
For T/S2068 (w/ Z-SI/O) and QL.

Avatex 1200<P> (300/1200).....\$125
<P>ocket size for the Z88.

Avatex 1200<E> (300/1200).....\$85
Great for SPECTERM-64!

Epson Compatible PRINTERS

Seikosha 1200AI (120/25)..\$199

Seikosha 180AI (100/20)..\$169

Star NX1000 (144/34)....\$229

All modems add \$3.50 for S&H, all printers add
\$10.00 for S&H (Canada double S&H on all items).

This Christmas Wish List is brought to you by:

Ed Grey Enterprises

P.O. Box #2186, Inglewood, CA 90305

Info >> 213-759-7406 << Order

Call The Grey Matter BBS & RCP/W (213-971-6260)

SEPTEMBER/OCTOBER 88

MAGAZINE EDITOR... Tim Woods
ASSISTANT EDITOR... Stephanie Woods
PRODUCTION..... D.L. Woods
Thomas Judd
Carol Judd

CONTRIBUTORS: Michael E. Carver,
Paul Bingham, Mike de Sosa, Earl
V. Dunnington, Syd Wyncoop, Stan
Lenke, Joe Williamson, David M.
Hutchinson, Duncan Teague, Herb
Bowers Sr., Michael J. Fellerski,
Bill Ferrebee, John Bell, Warren
Fricke, Fred Nachbaur, William
C. Andrews, Tim Stoddard, Dick
Wagner

RENEWAL TIME?? To determine your
expiration date, simply read the
date posted in the upper-right
corner of your mailing label.
The date posted is the last issue
you will receive. (Example:
"Nov/89" would indicate the
November/December 1989 issue.) A
renewal form is provided else-
where in this issue for your
convenience. Or simply send in
your payment, and indicate on the
check that it is for a renewal.

MOVING?? Please inform us as
soon as you know your new
address to prevent delay of
service and lost issues. The
U.S. Postal Service will not
reliably forward third-class
(bulk) mail.



© 1988 TIME DESIGNS MAGAZINE CO.
ALL RIGHTS RESERVED. PRINTED IN THE U.S.A.

NOTICE: Contributors to TIME DESIGNS are independent of the TIME
DESIGNS MAGAZINE CO., and opinions expressed in the contents of this
publication are not necessarily those of the management staff or its adver-
tisers. Time Designs Magazine Co. will not be held liable for any damage or
consequences resulting from instructions, assertions of fact, review of pro-
ducts or companies provided in the magazine's content. It is recommended
that anyone attempting to modify their computer or constructing an elec-
trical project should seek help from more knowledgeable individuals.

TIME
designs
MAGAZINE

The SINCLAIR
Computer Technology
Magazine

From The Editor

ABOUT THE COVER (part one)

Hey, that's my kid on the front cover!

If you've been a subscriber to TIME DESIGNS for
awhile, you may have noticed that I never really
mention a whole lot about my family or personal
matters. I have always felt that our customers pay
for computer information, and it's computer info that
you'll get. TS HORIZONS and CTM were two magazines
(now defunct) that I enjoyed, and remember reading
frequently about family members in their editorial
pages.

So what the heck. Just this once. Yep, that's my
two year-old son, Timothy Dean (or "T.D." for short).
As I am writing this column, my wife and I are
expecting our second child. It will be any day now,
and T.D. will have a little brother or sister.

And what is that curious vehicle that T.D. is
riding on? Hard core Sinclair fanatics will recognize
it at once. It's a Sinclair "C5" personal electric
vehicle. I had the opportunity to purchase a used one
here recently, and went for it. Now my son (who can't
really drive it yet) can brag to his friends that
he's the only one on the block with a C5.

Continued Next Page.

sinclair

Vehicles

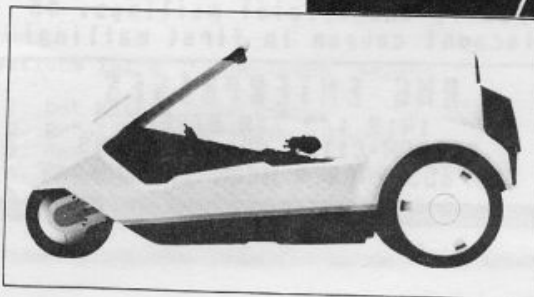

The C5 is the newest addition to my Sinclair "museum", which also includes a ZX80 computer, the pocket TV, the FM digital watch, and a whole bunch of Timex goodies, like the original Timex 2068 disk drive system (with Timex labels), and a genuine Timex joystick for the 2068. I keep looking for other goodies, and once in awhile (especially at the Timex computer shows), I run into another fellow fanatic who also has a collection. Such items as the original Sinclair programmable calculator, the Sinclair "black watch", and a 2050 modem with actual Timex logo decals.

But the C5 is certainly the centerpiece of my collection, and perhaps the strangest. It was a Clive Sinclair failure. I remember hearing about the research being conducted on electric vehicles several years ago. But I never imagined that the C5 would be the result of this research. A sort-of snowmobile on wheels.

I have taken my C5 completely apart, partly out of curiosity, partly to lubricate critical moving parts, and just general restoration. In doing so, I found the elusive Sinclair custom Integrated Circuit (chip) that monitors motor and battery status. It's a ULA, and I swear, it looks suspiciously like the one that resides in the ZX81!

The C5 went on sale for just a short time here in the U.S. through mail order, but I bet that only a few hundred were sold. The big problem was that the vehicle has a one-piece molded plastic body nearly six feet in length. Too big for UPS and Federal Express. I had to have it trucked from the east coast which added over \$100 to the price. Someone in engineering was not thinking. If only it could be folded up or disassembled into a smaller package.

And to add insult to injury, Sinclair had contracted HOOVER to manufacture the vehicle. Does that name sound familiar? It should, as just about every department store sells their line of vacuum cleaners! In fact, Hoover was also responsible for warranty service and parts. I called over to England to try and locate some parts my C5 was missing, and found that Hoover still stocks some of the items.

But after all of the criticism is raised about the C5, there is one aspect that is usually overlooked about the machine. It is darn fun to drive! It's a tad bit slow, but one trip around the block and your hooked. Everyone on the road will stare. There is simply nothing else like it around.

While it would be nice to close this little chapter of Sinclair history, and write the C5 off as a curious "boondoggle" that had some possibilities. But, lo and behold, I was told on good authority that Clive is still working on electric vehicles. Guess I'll have to make some more room in the "museum".

ABOUT THE COVER (part two)

Turning our attention back to the front cover of this issue...did you notice anything different??

A big "thank you" to Paul Bingham for designing our new TIME DESIGNS logo. I think it's clever and attractive, and I hope that you all like it too. This logo is the sixth revision to our very first logo which appeared on Volume One Number One. I had planned to unveil this new logo for the Nov/Dec issue, but I liked it so much, that I couldn't wait to showcase it.

We have the ever talented and artistic Paul Bingham working on some other projects for us. But he hasn't forgotten his CLASSY FRONT END column, which will resume next issue. Be sure to check out his write up and evaluation of the Z88 portable computer and how it sizes up to previous Sinclair computers, inside this issue.

In closing, I might add, that this issue contains a whole lot of pre-Christmas advertising from a variety of Timex Sinclair vendors. I do hope that you will patronize them in one way or another, as they support TIME DESIGNS. Why not drop a hint to Santa, that a new disk drive system, or software package is just the thing you need to further your "hobby"?

Tim Woods



The News is Out!

AND WE'RE SPREADING IT!

RMG is adding so many NEW and EXCITING ITEMS to our line that our storerooms are BULGING! We have added more than 25 NEW PAGES and changed over 20 others in our BIG 70+ page catalog. We want to make sure that you do not miss out on anything we may be able to help you with in your computing.

If you will send us \$3.00 you will receive our catalog with a \$3 off coupon for your first order. AND, send along 12 business size SASEs and you will receive 12 monthly updates and special mailings. \$5 discount coupon in first mailing!

RMG ENTERPRISES

1419 1/2 7TH STREET
OREGON CITY, OREGON 97045
503/655-7484 * NOON-10 TUE-SAT

CADZ U2.13

NOW ANYONE WITH 32K OF DOCK RAM CAN RUN CADZ. STILL JUST \$20.00
: Requires Artworx by Novelsoft:

- * DESIGN ON A 4 SCREEN PAGE
- * 7 PAGES WITH 256K (AERCO MOD)
- * 1 PAGE WITH MINIMUM 32K
- * 33 COMMANDS * FAST MC CODE

Send \$1 for docs, catalog and review by Duncan Teague.
Refunded with any purchase.

- * 32K INTERNAL RAM MOD. \$35.00
- * PURCHASE CADZ & 32K MOD BOTH FOR \$50.00
- * INSTRUCTIONS AND SCHEMATICS FOR INTERNAL 32K MOD FREE WITH PURCHASE OF CADZ
- * Tasword II and AERCO with 256k (4-drive only) holds five 300 line documents, (96,000 chr\$). \$15.00

ZUNK CUSTOM ELECTRONICS
4800 EAST CEDAR LANE
NORMAN, OKLAHOMA 73071
(405)-366 8595

When we ran a questionnaire/survey in several issues of TIME DESIGNS, we had over 280 responses, which is approximately eleven percent of our current circulation. The first part of the survey dealt with information about our subscribers (age, occupation, hobbies, etc.), and questions about equipment owned. You can read the results of this in the July/August issue. In this issue the survey concludes with reader input on hardware, software, and TIME DESIGNS itself. We sincerely hope that the data presented here will provide developers of software and hardware with a better understanding of our TS user community.

Most popular computer peripherals owned by TS users:

1. Westridge/Timex TS-2050 modem
2. modems (various brands)
3. Aerco Centronics printer interface (2068)
4. joysticks (various brands)
5. Zebra Talker (2068 and 1000 versions)

Software package that is used most frequently:

1. MSCRIPT (2068 word processor)
2. TASWORD II (2068 word processor)
3. QUILL (QL word processor)
4. PRO/FILE 2068
5. ZX PRO/FILE (TS1000)

Other software that is used (less frequently):

1. self-written "home brew" programs
2. miscellaneous games
3. PRO/FILE 2068
4. MSCRIPT (2068 word processor)
5. TIMACHINE (2068 BASIC Compiler)

Hardware (or computer) purchases this coming year:

1. 2068 disk drive system
2. dot matrix printer
3. Larken Ramdisk (TS2068)
4. modem
5. Z88 Portable Computer

Software purchases this coming year:

1. Jack Dohany's MSCRIPT Version 6
2. PIXEL PRINT PROFESSIONAL (2068)
3. any good 2068 spreadsheet
4. miscellaneous 2068/Spectrum games
5. QL programming utilities

What Hardware would you like to see developed?

1. 2068 bankswitching (BEU) like Timex promised
2. additional external/internal RAM for 2068
3. external I/O board for controlling devices
4. larger RAM for the TS1000
5. 2068 optical scanner
6. IBM/MS-DOS emulator for the QL
7. better voice processors for Timex computers
8. cheaper disk interface board for the 2068
9. IBM/MS-DOS emulator for the 2068
10. PC-style keyboard/interface for the 2068

What Software would you like to see developed?

1. better 2068 business programs
2. high-resolution word processor (TS1000)
3. educational software for the 2068 (all ages)
4. spelling checker for the 2068
5. more arcade and adventure games for the 2068
6. simpler database for the QL

7. stock market/investment software (2068)
8. more plug-in cartridge software for the 2068
9. music programs utilizing sound chip(2068)
10. 2068 astronomy software

Comments about TS vendors/dealers:

1. "generally good to excellent service"
2. "we need your support...don't give up"
3. "not enough of them"
4. "more product documentation...less tech talk"
5. "delivery is sometimes slow"

Most favorite section in TIME DESIGNS:

1. Sinclair News
2. anything on the 2068
3. program listings
4. TS Communique (Joe Williamson)
5. advertisements
6. QL section
7. hardware projects
8. product reviews

Least favorite section in TIME DESIGNS:

1. don't have one
2. QL section (because I only have a 2068)
3. 2068 section (because I only have a QL)
4. 1000 section
5. games
6. non-Sinclair information
7. long complex programs

One particular favorite article or program listing:

1. "Classy Front End" series by Paul Bingham started MARCH/APRIL '87
2. "Z80 Machine Code" series by Syd Wyncoop started MARCH/APRIL '86
3. "MAX 1000" by Tim Stoddard SEPT/OCT '87
4. "Z88 Portable Computer" review by Tim Woods NOV/DEC '87
5. "Mystery of the Missing 253" by Wes Brzowski started JULY/AUGUST '86
6. "87 Tax Calculator" by Herb Bowers Sr. JAN/FEB '88
7. "QL Mandelbrot" series by Michael Carver started NOV/DEC '87

Comments to the Editor of TIME DESIGNS:

1. "keep up the good work"
2. "please don't quit"
3. "only feature TS information in TDM"
4. "thanks for publishing the magazine"
5. "more QL articles please"

An article/program you would like to see in TDM:

1. Machine Code programming tips (2068 and 1000)
2. QL Machine Code programming
3. Larken disk drive system tips (2068)
4. how to use a spreadsheet program
5. BASIC programming "tricks"

Suggestions for a "theme issue" topic:

1. Dot Matrix Printers
2. Robotics/Controlling Things
3. Games
4. Music
5. Word Processing

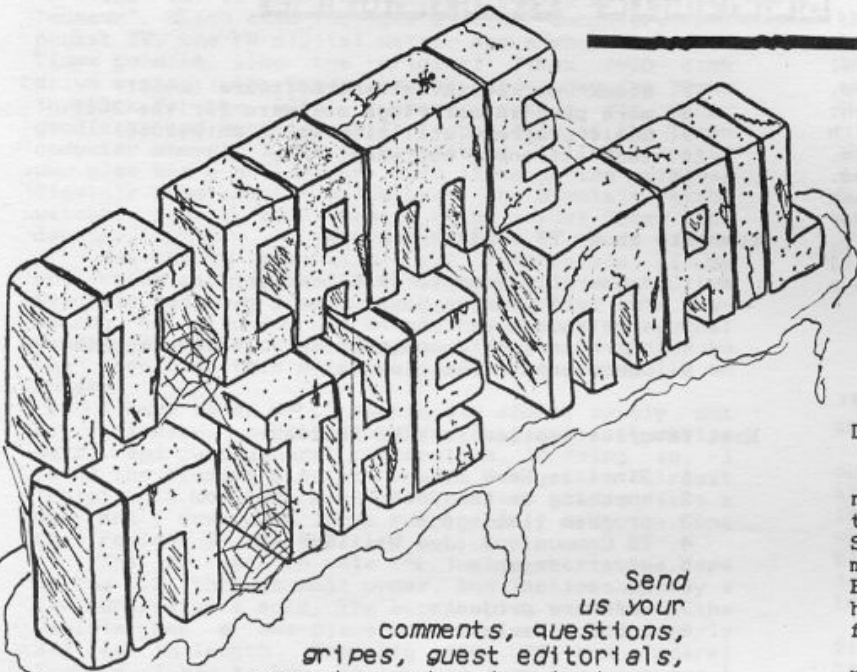

Send us your comments, questions, gripes, guest editorials, computer artwork, short program listings, and helpful hints (no candy wrappers or photos of your mother-in-law please). We will print as many as space allows. The Editor reserves the right to accept or reject contributions, and to make insipid comments in the space between columns.

2068 PUZZLE SOLUTION

George Mockridge, of Daly City, California, sent in this TS2068 program he wrote to solve the PUZZLE OF THE MONTH (July/August '88) by the late Cedric R. Bastiaans. It can be compiled with TIMACHINE, the BASIC Compiler.

- The Editor

```

1 REM Solution for Puzzle of
Month - July/Aug. TIME DESIGNS.
Program by George Mockridge.
Can be compiled using TIMACHINE.
3 REM !INT +i,j,k,l,m
4 REM !INT a
5 REM ! OPEN #
9 CLS : LET a=-1: PRINT "Work
ing on problem.": PRINT
10 FOR i=1 TO 24
20 FOR j=1 TO 24
30 FOR k=1 TO 24
40 FOR l=1 TO 24
50 FOR m=1 TO 24
60 IF i+j+k+l+m=40 THEN GO SUB
100
65 IF a=1 THEN STOP
70 NEXT m: NEXT l: NEXT k: NEX
T j: NEXT i
75 STOP
100 IF i*j=39*(k*(l*m)) THEN LET
n=((i+1)*(j+1))/((k+1)*(l+1)*(m+
1)): GO TO 103
102 GO TO 110
103 GO SUB 300
105 IF a=1 THEN PRINT "2 BOYS A
GES - ";i;" ";j;" : PRINT "3 GIRLS
AGES- ";k;" ";l;" ";m
110 IF i*j*k=39*(l*m) THEN LET
n=((i+1)*(j+1)*(k+1))/((l+1)*(m+
1)): GO TO 113
112 GO TO 200
113 GO SUB 300
115 IF a=1 THEN PRINT "3 BOYS A
GES - ";i;" ";j;" ";k;" : PRINT "2
GIRLS AGES- ";l;" ";m
200 RETURN
300 LET a=1: IF (INT (n/2)*2-n)
<>0 THEN LET a=-1
301 RETURN

```

DIRT CHEAP PRINTER

Dear Tim,

This is a note to inform your readers that it is now feasible to run the IBM PCjr thermal printer on the TS2068 computer. I am a late comer to the Timex Sinclair scene and thus did not get in on the initial movement to full size printers such as the Gorilla Banana, Star 10, and others. But now there are hundreds of these PCjr thermal printers on the market for about \$30 to \$35.

Granted printers keep improving and getting more reasonable in price, but for the low-budget hobbyist, this has to be one choice to consider.

The PCjr printer I purchased has a serial input port and is interfaced to my TS2068 through Ed Grey's Z/S-IO serial board (available from ED GREY ENTERPRISES) I am using print driver software written by Larry Kenny (LARKEN ELECTRONICS) for his LKDOS cartridge system. I also purchased from the printer vendor (see address at the end of this letter), a conversion plug to go from the IBM printer to the RS232 serial board on my computer.

It is also possible to run the printer using a modified version of John Bell's "Serial Port Driver" program you published in the JAN/FEB '88 issue of TDM. John McMichael (1710 Palmer Dr., Laramie, WY 82070).

The thermal printer has limitations, such as the use of special paper, it's a non-permanent record, etc. But I think it is a good deal for the limited hobbyist. I solve the paper problem by scrounging the end rolls of FAX paper, from a large corporate facsimile operation that buys 600 foot rolls, and throws away the roll ends so that the machine will not run out of paper while unattended. For permanent copies of important documents, I run them through a copying machine.

I class myself as a casual user and find the larger printer increases the utility of my "toy" computer a great deal. The real work on this system came from John McMichael, Larry Kenny and Ed Grey. I just asked each of them for their contribution. The print driver software uses the LPRINT and LLIST commands, but doesn't use the COPY command.

John Austin
McKinney, Texas

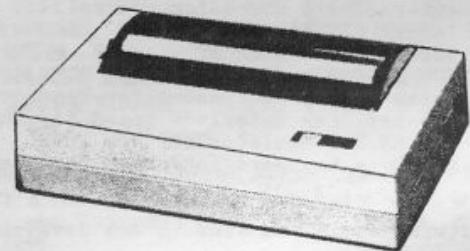

The full-size thermal printer discussed and pictured above can be purchased from B.G. MICRO, P.O. Box 280298, Dallas, TX 75228, phone (214) 271-5546, for \$29.95 + \$4.00 shipping (U.S.). The printer was manufactured by CANON for the IBM PCjr. An optional PC AT/XT type connector is available for \$3.00. Paper is available from Radio Shack and other sources. The printer may be available from other dealers who deal in surplus hacker supplies.

- The Editor

2068 HELPS ARMY

Dear Tim and Staff,

I think Paul Bingham and Stan Lemke, along with all the others, deserve a big thank-you for the programs they have donated to your magazine. Has anyone thought of consolidating them on a disk/tape and offering them to others through the magazine? The revenue could be used to offset production costs. That way we all win.

The following is a graphic that I use for a coversheet on the operator's manual exam my pilot's have to take. Although not drawn with a commercial graphics program (simple PLOT/DRAW commands were used), I did use TECH DRAW JR (Zebra Systems) for the shading.

John Bailey
Chief Warrant Officer
United States Army
APO, San Francisco

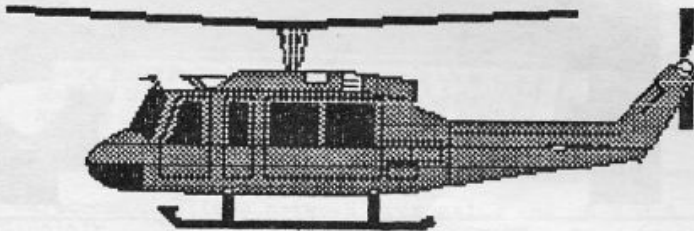

UH-1H Helicopter (US Army)
Drawn by: John Bailey

Nice pic John! About your suggestion: currently we are understaffed to offer all of the listings in each issue on a tape or disk. While it would be nice, just think about all of the different formats that would have to be offered (TS1000 tapes, QL microdrive cartridges and disks, TS2068 tapes and disks in four different formats, not to mention double-sided and quad-density disk systems). However, most of our contributors, including Paul Bingham, Stan Lemke, Michael Carver, William Andrews, and others, will offer most of their programs published in TDM on a tape for nominal charge. Even if it isn't stated in the article or program, it would be worth your while to contact the author either directly or through TDM to see if this service is available.

- The Editor

QL MACHINE CODE

Dear Tim,

I have a question that you may be able to help me with. I want to write some machine code functions and link them into the name table. I own the "QL Technical Guide" and the book, "Machine Code Programming On The Sinclair QL". I understand how to actually link functions and procedures, but I don't see how to transfer the answer back to SuperBASIC. Also, how do I get the parameters passed to my code. Would you be able to explain this or refer me to some source that could? I've read section 9.0, "Interfacing to SuperBASIC" in the Technical Guide, but I'm still a little unclear about it all. A simple example would be most helpful. Such as, a function that would take two parameters and add them.

I would really like to see more technical articles for the QL in TDM. Similar to what I've asked. The QL is a powerful machine, but the manuals are lacking in explaining its full uses. I'm presently a graduate student and don't have the time to go through deciphering exactly what was meant in the manuals. Any additional help would be greatly appreciated. Thank you for your time and advise.

David McCall
Rochester, New York

I asked our resident QL Machine Code programmer, Michael Carver for some references on how to pass parameters to SuperBASIC, and then to code. He has recommended the books "The Sinclair QDOS Companion" (published by Sunshine), pages 121-126; and "Advanced QL Machine Code" (published by Duckworth), pages 82-100. These books may still be available from a QL dealer.

Your request for technical articles has been honored. Starting in this issue, Michael Carver will begin a new series, with the first article detailing how to extend SuperBASIC by installing semi-permanent PRO- cedures and FuNctions. A follow-up article will discuss creating and running Jobs on the QL.

- The Editor

FOR THE YOUNGER SET

Here is a very simple BASIC TS2068 program which will teach your kids their alphabet (both CAPS and small) and numbers, as well as the QWERTY keyboard.

Two of my grandsons learned this way, and now my 20 month old granddaughter is "pecking away".

Change the name of the bus line to their own (in Line 300) and watch them grow.

Earl L. Kielgass
Tempe, Arizona

```
10 REM "BUS "
11 REM *ADD LINE 13 AND ENTER
POKE 23658,0 FOR SMALL LETTERS 0
R POKE 23658,3 FOR CAPITAL LETTE
RS. DELETE LINE 13 FOR NUMBERS.*
12 REM *LINE 100 AFTER CHR$ SH
OULD READ (RND*24+97) FOR SMALL
LETTERS, (RND*25+65) FOR CAPS, A
ND (RND*9+48) FOR NUMBERS.*
13 POKE 23658,0
15 BORDER 4: PAPER 6:
21 PRINT AT 4,0: "PRESS KEY OF
LETTER OR NUMBER SHOWING ABOVE
BUS DRIVERS'S HEAD"
90 RANDOMIZE
100 LET L$=CHR$ (RND*24+97)
200 FOR N=0 TO 31
300 PRINT AT 9,N; " TDM
": INK 2
305 PRINT AT 10,N;" _____
": INK 0
310 PRINT AT 11,N;" BUS LINE
": INK 1
315 PRINT AT 12,N;" _____
": INK 1
320 PRINT AT 13,N;" 00
0": INK 0
335 PRINT AT 13,N;" 00
0": INK 0
340 IF N=34 THEN GO SUB 1010
350 NEXT N
360 PRINT AT 13,0;"": INK 2
365 PAUSE 20
370 PRINT AT 13,0;"": INK 2
377 PRINT AT 15,17;"STOP": IN
K 2:
378 PAUSE 20
379 PRINT AT 15,17;" "
INK 2
380 IF INKEY$="" THEN GO TO 340
390 IF INKEY$<>L$ THEN GO TO 42
0
391 CLS
394 GO TO 21
420 GO TO 380
1010 PRINT AT 9,12;L$
1030 RETURN
```

the NEWSROOM

A SINCLAIR IBM "CLONE"?

Late one morning in the TDM office, I received a rash of phone calls, one right after the other, and all concerning the same thing. An anxious voice on the other end of the line would ask, "have you seen the new Sinclair computer advertised in POPULAR SCIENCE magazine?" Then sounding as if a friend had betrayed them, they would add, "it's an IBM clone".

I admitted that I hadn't heard about it or seen one (but thought to myself it sounded a bit fishy). By about the third or fourth call from one of our customers, I had my coat in hand, and was headed down to the drug store to secure a copy of the magazine.

And sure enough, towards the back of the publication was a full page ad with a black and white photograph (see example) showing a complete computer system including a monitor, a printer and a mouse. The logo depicted on the equipment was unmistakable. The familiar black and white Sinclair trademark.

But wait. There was also something familiar about that computer. It looked suspiciously like an AMSTRAD PC-1640.

It wasn't until a month later, that I heard the complete details behind this mystery computer. It was at the Midwest Sinclair Conference in Cleveland, Ohio, during a lecture by Nigel Searle (a business associate and personal friend of Clive Sinclair).

Nigel told the audience that when the Z88 portable computer came to the U.S., the national distributor took on the business name of "SINCLAIR SYSTEMS INC."...until, that is, lawyers from AMSTRAD showed up. They said, "no way...we hold the exclusive world-wide rights to the SINCLAIR name".

Indeed, back in 1986, Clive sold his computer company to save his faltering research organization. But through some hazy clarification, Clive thought that the deal signed with AMSTRAD only included the exclusive use of the Sinclair name in Europe. But AMSTRAD, and it's shrewd chairman, Alan Sugar, had other ideas.

To avoid a nasty legal battle, the Z88 distributor instead elected to use the simple initials, "SSI". But it was reported, that Alan Sugar and AMSTRAD still harboured ill feelings toward Clive, thinking that he somehow tried to cheat them.

It was at the Chicago Consumer Electronics Show, that this clash came to a head. By chance, AMSTRAD and SSI had adjoining booths. Both Nigel Searle and Clive Sinclair were there to promote the Z88.

When they looked over at the AMSTRAD booth, they couldn't believe their eyes. Right out in front was one of AMSTRAD's Korean-made PC clones. And where the logo should have been, somebody had taken the old Sinclair logo (literally cut out of a magazine or brochure), and had scotch-taped it over the AMSTRAD logo!

It was very obvious that Alan Sugar was trying to "punish" Clive Sinclair. It is well known that Clive has never had any desire to produce an MS-DOS machine. Just look at how non-conforming the Sinclair computers have been, right down to the black plastic cases (no beige here).

Originally, the sale of his computer company and certainly the use of his name by a competitor, bothered Sir Clive a bit. But now, looking at these "disguised" computers, both Nigel and Clive chuckled out loud.

So thus the story of the Sinclair "clone". However, we did hear from a reliable source, that AMSTRAD will market this "new" computer, banking on increased sales, even though both the similar AMSTRAD model and the re-packaged "Sinclair" model will both be sold simultaneously here in the U.S. Supposedly the AMSTRAD PC stock hasn't moved to Alan Sugar's liking. With the Sinclair version, he is counting on name familiarity.

Will the old TS1000 and ZX-81 owners (at one time, nearly a million strong) be fooled by this "wolf in sheep's clothing"?

- Tim Woods



SUMMER T/S SHOWS

Small crowds, large exhibitor displays, and excellent guest speakers, marked the opening of summer Timex Sinclair computer shows in two different geographical locations.

The Third Annual Northwest/International Timex Sinclair Mini-Fair "kicked off" on August 6 and 7, at the Cosmopolitan Hotel in Portland, Oregon. The event, produced by Rod Gowen, was organized and structured very professionally, and was compared in some aspects to the Indianapolis Timex show held last year.

Ed Grey (Ed Grey Enterprises) demonstrated modems, serial cards, and digitized video. Sharp's Inc. had a full spread of QL and Z88 items. RMG Enterprises featured printers, monitors, and disk drive systems stacked shoulder high. But Zebra Systems had the largest display, with ten tables full of TS1000 and TS2068 merchandise.

Nigel Searle, representing SSI and promoting the new Z88 portable computer, shared a booth with George Whitham of A+ Computer Response. Jack Dohany had a customized work station that allowed him to produce 2068 software for a variety of systems and disk drive formats. Time Designs and Foote Software also had some displays.

Not to be out-done, the users groups provided some interesting things to look at. At the CCAT/S booth, Ed Fry demonstrated his four-port expansion decoder for the TS1000 (see his article on the decoder in this issue of TDM). Another TS1000 operated a Radio Shack robot arm at the SEATUG booth. VISTA demonstrated a Larken disk drive system and provided information on a public domain software exchange. Both the Vancouver and Las Vegas groups provided newsletters and information about their groups activities.

Guest speakers in the seminar room included Jack Dohany, Mike de Sosa, Wilf Rigter, Ed Grey, Harvey Taylor, Michael Carver, Nigel Searle, Vince Lyon, and Dick Wagner.

Late Saturday night, a special "Round Table" session was held (open to the public), with many of the guest speakers presiding, fielded questions from the audience. Several computer topics were discussed, including "shareware", copy protection, software piracy, computer viruses, the Z88 portable computer,



TOP: Timex/Sinclair users who participated in a special meeting on Saturday night in Cleveland, Ohio. One of the topics discussed was the feasibility of S.N.U.G. (photo courtesy of Tom Simon) MIDDLE: Jack Dohany discusses disk drive systems for the 2068 at the Portland show. (photo courtesy of Tom Moll) BOTTOM: Mike de Sosa lectures on his favorite subject, the Sinclair QL, at the Portland show. (photo courtesy of Tom Moll).

a telecommunications network proposal, and S.N.U.G. (Sinclair Northamerica Users Group...an idea originally initiated by some individuals at the computer fest in Florida).

Next, it was off to the 1988 Midwest Timex Sinclair Conference, which was held on August 27 and 28, at the Beck Center for the Arts, in Lakewood, Ohio (a suburb of Cleveland). The Greater Cleveland Sinclair Users Group was the host, headed by the very capable Andy Kosiorek. The community theatre complex, only a few blocks from the shore line of Lake Erie, was a fine location for a computer show.

Most of the dealers who attended the Portland gathering, were also in attendance at Cleveland, with the addition of Dan Elliott (computer repair technician), Bryce Road Pharmacy (an Amstrad dealer), Budget Robotics & Computing, and Syncware News.

Along with the Cleveland group, the Capital Area T/S Users Group, the Indiana Sinclair Users Group, the SAF (Michigan) Users Group, and the Southwest Pennsylvania Users Group, had computer displays.

Seminars were provided by Tom Bent, Nigel Searle, Bruce C. Taylor, James Dupuy, Ken Wildman, Frank Davis, Gary Ganger, Basil Wentworth, David Hoshier, Ron Lutz, Bill Bell, and Ken Wildman.

The seminar presented by Nigel Searle drew the most attention. The topic was "Sinclair History-ZX80 to Z88" and included a visual presentation that traced the evolution of the ZX80 and ZX81 computers. Nigel has been a business associate and close friend of Clive Sinclair for over 15 years. He related many humorous stories and an insight into the development of our favorite hobby.

On Saturday night, a special users meeting was held for anyone interested, and the major topic of discussion was S.N.U.G. In attendance was Mel Nathanson, one of the key individuals who started the concept, and is currently pro tem Chairman of S.N.U.G. He gave a brief presentation and shared some ideas. There were both positive and negative comments from the audience during an open discussion period. The meeting wrapped-up with a group photo (the result of which can be found in this issue), and a catered dessert social afterwards.

The producers of both shows were marginally disappointed in the numbers in attendance. One individual, who asked not to be identified, discussed this problem at length.

"If all of the locals had showed up, it would have been a success. If all of the people who wrote or told me over the phone they were coming, had



showed, it would have been a success". He then added, "I talked to this one 2068 owner who is within driving distance, and he was almost shocked when I asked him if he was coming to the show. No, he replied, but I do want to attend a show sometime. What this guy doesn't realize, is that if folks don't get behind these shows and support them...there won't be anymore shows!"

Another show promoter attributed the low numbers to the less-than-desirable show scheduling, and the declining number of users interested in Timex Sinclair computers.

Over-all, the single most important component of these public gatherings is the exchange of vital information. At both the Northwest and Midwest shows, the guest speakers were captured on video tape, and are available for those who were unable to attend. A wide variety of topics is offered. For further details on prices and a list of topics, contact the following representatives. Northwest Mini-Fair: Rod Gowen, 1419 1/2 7th Street, Oregon City, OR 97045. Midwest T/S Conference: James Dupuy, 6514 Bradley Ave. (down), Parma, OH 44129.

- Tim Woods

SPECTRUM PRODUCT NEWS An Eye On Great Britain



Though many believe that our little computers are dead, the best way to prove them wrong, is by showing them the amount of Spectrum hardware and software coming out of Great Britain and Europe these days. For the Timex Sinclair 2068 owner, this may mean the addition of a "twister board" for the rear port (available from John Mathewson, 1852 Appleford St., Gloucester, Ontario, Canada K1J-6T4), and a Spectrum ROM (available from Zebra Systems and Russell Electronics), but it is well worth the money to open up your world to thousands of software titles and hundreds of hardware add-ons. Here are some of the latest additions to this growing list.

Datel Electronics Ltd. (Fenton Industrial Estate, Govan Road, Fenton, Stoke-On-Trent, England, phone 0782-744707) has introduced the ROBOTARM, a robot arm and interface for the Spectrum. The arm is more versatile than Radio Shack's "Armitron", with 5 axis manipulation and the ability to pick up objects as small as paper clips and as large as a tennis ball. The ROBOTARM includes a magnet and scoop, and can operate without a computer via two joysticks. The ROBOTARM costs £49.99, and the Spectrum interface with control software costs an additional £19.99. Datel Electronics accepts VISA credit card orders.

Romantic Robot UK Ltd. (54 Deanscroft Ave., London, England NW9 8EN, phone 01-200-8870), is now offering the VIDEOFACE, video digitizer for £44.95. The VIDEOFACE converts pictures from a video camera or recorder into standard hi-res Spectrum screens. The VIDEOFACE uses a standard composite video signal and the software (included) is menu driven. Romantic Robot UK Ltd. accepts VISA credit card orders.

Remember the ROTRONICS WAFADRIVE? They are now available from Logic Sales Ltd. (19, The Broadway Southgate, London N14, England, phone 01-882-4942). These are the same stringy floppy drives and operating system that were sold here in the states a couple of years ago. They are currently priced to sell out at £14.99. Logic Sales also has 16K and 64K wafer cartridges at £2.00 and £3.50 respectively.

JUST RELEASED

TS1000/TS1500

A comprehensive Timex/Sinclair Public Domain Software Library is maintained by the VISTA (Vashon Island, Washington) group and is available to the general public. Currently there are six 60-minute cassette tapes of programs for the TS1000. Programs for the 2068 will be offered shortly. Tapes can be obtained for a nominal fee that covers the cost of a quality blank tape, postage and handling, etc. For complete details, write to: Tim Ward, 5142-D Ginkgo Dr. S.W., Tacoma, WA 98439; or Tony Willing, PO Box 199, Vashon, WA 98070. The group is also looking for, and will gladly accept program submissions/donations to the library.

TS2068

One of the top stories in our last issue's news section, was a hardware device and software to allow 2068 users to attach an OKIMATE 20 color printer. The trick was to purchase the optional Commodore (serial) "Plug 'N Print" package. But now, a much simpler solution has come to light by John McMichael, the same individual who developed the Commodore emulation I/F and software. By selecting the IBM (parallel) "Plug 'N Print" package, it will adapt directly to an AERCO Centronics/parallel printer interface (or Oliger and Foote Print). No other hardware is required. Standard Aerco-type printing software should work "as is". However, John McMichael has re-written his COLOR COPY (color screen dump utility) program for this new interface configuration. COLOR COPY is priced at \$8.95 ppd. For details, write to John McMichael, 1710 Palmer Dr., Laramie, WY 82070.

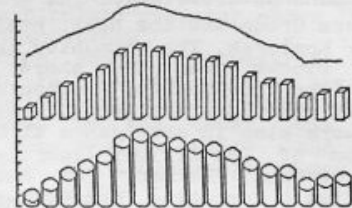

There has been a great demand for "serious" 2068 business software. GRAPHIT-1 might just fit the bill. GRAPHIT-1 offers the choice of six different graph types (see examples above), up to 18 separate input values can be graphed, and the full-size printer support section (AERCO I/F compatible) can be user customized. A joystick is required, as the menus are selected similar to the way a "point 'n click" mouse works. GRAPHIT-1 is reasonably priced at \$5.00 + \$1 S&H, from a brand new company, BOTTLE CAP SOFTWARE, 1284 Brushwood Ave., Cincinnati, OH 45224.

An outstanding "excuse" to keep your faithful TS2068 working, rather than trading it in for a new model, is the software coming from BYTE POWER. If the new titles now being released are anything like their previous programs, 2068 fans are in for a real treat. THE PRINT FACTORY will unleash "PRINT SHOP" power and flexibility upon your full-size printer, with eight separate programs, and over 150 graphic

These are the same wafers used with the A&J Micro-drive system. Logic Sales accepts VISA credit card orders.

TASCALC is Tasman Software's new 52 column x 157 row spreadsheet software package. The Spreadsheet includes on-screen help and interactive prompts. In addition to TASCALC, there are several other new programs for the Spectrum+ 128K and Spectrum+ 3 series of computers. Write to Tasman Software (Spring Field House, Hyde Terrace, Leeds, LS2 9LN, England) for further details, or phone 0532-438301. Tasman Software accepts VISA credit card orders.

- Michael J. Fellerski

designs included. 2+FAST is a "fast load" software system, that will SAVE and LOAD your tape data up to 2.5 times faster. THE VOICE is a speech development system that includes a headset microphone. BYTE POWER also operates a "software magazine" on tape, with around ten programs per issue. The most recent one contained a very impressive program called SPREAD-SHEET II (64 columns, joystick controlled). Most all of BYTE POWER's programs will operate on the Spectrum too. For further details and prices, write to: BYTE POWER, 1748 Meadowview Ave., Pickering, Ontario, CANADA L1V-3G8.

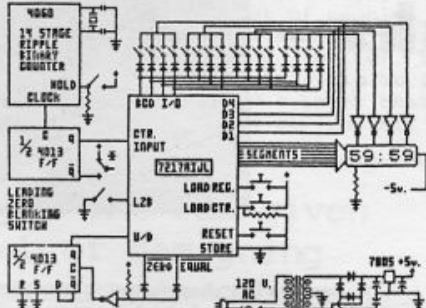

Some pretty fascinating stuff coming out of ZUNK CUSTOM ELECTRONICS (4800 E. Cedar Lane, Norman, OK 73071). Larry Zunk, owner/operator, has developed a software system called CADZ (requires Novelsoft's ARTWORX and 32K additional Dock RAM...which is available from various sources, including ZUNK). To prove the usefulness of CADZ, Mr. Zunk has used it to design an electronic fuel injection system, a monitor for a MAZDA rotary engine in an experimental airplane, and a computer-controlled driverless steering system for an experimental mass-transit vehicle. (Note: See the sample screen dump above.) For an information packet, including software/hardware catalog and documentation, send \$1 to address posted above. The buck is refunded with any purchase.

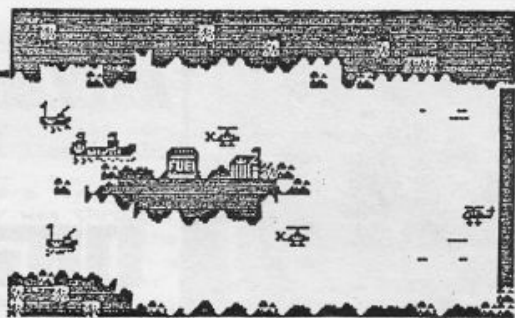

Several arcade games for the 2068 and Spectrum are available from MAGICKSOFT (735 S. Cline Ave. #11, Newton, NC 28658). A sample screen from GULF WAR is shown above. Write for further information.

SINCLAIR QL

Serious QL users will be interested in a new catalog that lists many unique and useful software packages, all of which were developed by North American programmers. The catalog lists business and financial titles, disk and programming utilities. Get your free copy today, by writing to: EMSOFT, PO Box 8763, Boston, MA 02114.

META MEDIA PRODUCTIONS (726 West 17th, Vancouver, B.C., CANADA V5Z 1T9) has announced that they are now marketing their Q_LINK terminal software as "shareware". Q_LINK author, Harvey Taylor, reported that he had learned that his program was being pirated (illegally copied and distributed) around the U.S. Promoting Q_LINK as shareware is the companies response to this nagging problem. Those who wish to officially register their copy of Q_LINK, can send \$15, and receive a) copy of the user manual, b) telephone support, c) news about future updates, d) further support wares such as Unarc, Uncrunch, Filters, etc., as they become available. Currently, Q_LINK version 1.556 is available.

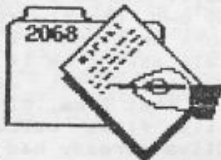

PIXEL PRINT PROFESSIONAL!

THE DESKTOP PUBLISHER

by: Lemke Software Development

2144 White Oak
Wichita, Ks. 67207



T5-2068

- * based on the Pixel Print PLUS! Desktop Publisher
- * Bank-Switching for Perfect Page Layout, 64 col. printing
- * AERCO, LARKEN, OLIGER Disks (\$29.95 all versions)
- * IBM/EPSON/STAR/PROWRITER Compatible Graphics
- * 72 to 90 Dot per inch printer graphics required



PIXEL PRINT 1989 PERSONAL CALENDAR PLUS!

- * 14 Month Calendar
- * Loads into Pixel Print DTP (versions 3.1 thru 3.6)
- * Personalize it with the DTP
- * Print 1 or 4 months per page
- * Comes with 88 Calendar ICONS
- * PLUS! ICON Library Manager
- * \$19.95 ppd (order today)



JANUARY 1989

| SUN MON TUE WED THU FRI SAT | | | | | | |
|-----------------------------|-------|-------|----|-------|----|-------|
| 1 NEW YEAR'S DAY | 2 | 3 | 4 | 5 | 6 | 7 |
| 8 | 9 | 10 | 11 | 12 | 13 | 14 |

EXCLUSIVE INTERVIEW

NIGEL SEARLE

“Sinclair insider”

BY TIM WOODS

It was very early on a Sunday morning, and it was pouring down large rain drops, quite warm and humid, but drenching indeed. Perhaps the weather was fitting for the occasion...similar to the climate of Great Britain, the homeland of my distinguished breakfast guest (and certainly of the Northwest where I reside).

This was the second day of the Midwest Sinclair Conference in Cleveland, Ohio. The previous day, I had sat in on a very interesting seminar on the history and development of Sinclair microcomputers, conducted by Nigel Searle. Nigel had worn several hats in the Sinclair hierarchy, including top executive, second in command, right under company founder Clive Sinclair; and then later, the U.S. Marketing Director of Sinclair Research in Boston.

I guess that I have always had this preconceived notion, that Sir Clive Sinclair was this very proper "stiff-lipped" English inventor; but Nigel quickly shot down this view during his lecture. Nigel has known Clive for over sixteen years, both as a business associate and as a close friend. Nigel related several humorous stories, including Clive's antics at a company Christmas party, about an incident in a pub, and his dealings with British bankers. One year, when the Ministry of Education denied approval of the Sinclair ZX81 for use in the primary schools (but instead granted approval to Apricot, a competitor), Sinclair re-submitted a "brand new" model, the Spectrum. But unknown to the Ministry, was that this particular computer submitted for review, actually had a ZX81 mother board installed inside! The "new" computer was promptly approved.

During the early years with Sinclair, Nigel found himself frequently commuting to the United States. At first, working with Texas Instruments, to program a custom chip that would be used in a Sinclair scientific calculator; and then later, to promote new Sinclair computers.

Currently, Nigel resides in the U.S., and is the owner and operator of The Marketing Clinic in Keene, New Hampshire, a public relations and marketing firm. He also helps produce a weekly radio show on personal computers, heard in the New England area.

Nigel continues to work with Sinclair in an outside consultant capacity, and was brought in to help SSI (and other affiliates of CAMBRIDGE COMPUTER-North America) promote the new Z88 portable computer, and future computer product releases.

Nigel, without hesitation, generously agreed to do an interview for TIME DESIGNS. To reminisce about the "early days" of Sinclair computers (including the QL, which for the most part, was his project), and to offer a few clues as to what we can expect from Sir Clive in the not so distant future. And so, over breakfast, the following exchange occurred.

Tim: First of all, for those TIME DESIGNS readers who weren't fortunate enough to attend your lecture here in Cleveland on the "history of Sinclair computers", let's go back a bit. What were your "roots" (like the Alex Halley novel)? How did you become a member of the Sinclair "legacy"? Basically, how did it all begin?

Nigel: It actually happened through an organization known as MENSA, which I had become a member of, when I was in college. When I was about to graduate, someone who I knew through MENSA, introduced me to a guy called Tim Idelwatt, who had started his own company in Cambridge, England. And as a result of that meeting, I was offered and accepted a job with Tim's company. Tim was a friend of Clive Sinclair, and through Tim, I met Clive who also happened to be a member of MENSA.

I worked for CAMBRIDGE CONSULTANTS, Tim's company, for a couple of years then decided to leave the company and work on my own. I guess that I felt they were paying me relatively little. All they were providing me with was a pencil and paper, and a place to sit, and then they were charging clients about five times as much as they were paying me. And I'd also, because of the circumstances under which I had gone to work there, I'd been thrown into the position where I had to find clients myself. And so I figured I could do it just as well on my own. Shortly after I left Cambridge Consultants to work on my own, I got a phone call from Clive Sinclair asking me if I was interested in working on a calculator. That was in the middle of 1972. Right at that time, SINCLAIR RADIONICS was bringing out its first calculator called the "Executive", but Clive already had plans to work on a scientific calculator, and that was the first project I worked on.

For quite a while there, I wasn't a full time employee. I'd made the big break and decided that I wanted to work for myself, to work as a consultant. Although I had an office at Sinclair, and spent quite a lot of time working on that project, I didn't work there full time and I worked on other projects for other clients as well. It (the calculator) was certainly the major thing that I was working on for a few years there.

Tim: How long had Sinclair Radionics been around before you joined on?

Nigel: Sinclair Radionics had been around for almost ten years, and had been doing mainly audio, started selling parts initially, amplifiers, kits, and later, just before I joined them they started selling speakers and stuff like that.

I really only knew Clive and his company through his friendship with this guy Tim Idelwatt, who ran Cambridge Consultants, and as someone who was running a business locally. To tell the truth, at Cambridge Consultants where most of the employees were graduates of Cambridge University and a lot of them had advanced degrees, and we tended to look down our noses a little bit at Sinclair Radionics. The technical people at Sinclair weren't as well educated and as well qualified as we were.

I guess if there was any perception of what Sinclair was all about was that it was a crass commercial organization compared to the almost ivory tower stuff that we used to do at Cambridge Consultants.

Tim: (chuckling) But it was a job...a paying job. (more seriously) It seems like Sir Clive had a talent for bringing into his company key people with bright ideas. Is this a quality that you noticed?

Nigel: Well, Clive had never been to college. That was a conscious choice that he made. I think he was very sympathetic toward the idea that formal education doesn't necessarily have much to do with ability. And so he tended to look for different qualities in people other than formal educational qualifications. And so, yeah there were a lot of people who were pretty bright, creative sort of people. People who may not have been too happy in a more conventional organization. A lot of people like that played a big part in Sinclair's success over the next few years. And interestingly, a lot of them, when they eventually left Sinclair, did so to go and start their own businesses. And I think that's a credit to the company. I think Clive always felt that

"The guy who was given the job of designing the appearance of the QL was given a 2068 with instructions to take a close look at it..."

if somebody left the company to go and work for someone else, that was their problem and that they probably hadn't ever really been good enough to work for him anyway. But if they left to go and start their own company he was extremely supportive, however sorry he may have been to lose them, and he frequently used them if the company they had started did any sort of consultant work.

Tim: Let's advance history a little bit with the ZX80 and ZX81. As far as the Sinclair following over here, a lot of people consider Sinclair BASIC and the single keystroke command function as superior engineering features. How much influence did Sir Clive have over that design, or did he bring in someone with that idea?

Nigel: I really don't know. When I first saw the ZX80 in January of 1980, shortly before it was launched, Clive showed it to me to explain to me what his new company (SINCLAIR RESEARCH LTD.) was going to be doing. Those features were already designed into the ZX80. My guess is that the keyboard stuff probably came from Clive. In 1975 I had worked on the design of a programmable scientific calculator which for reasons of economy and compactness, Clive had wanted to put into the same case, a very small calculator which had been designed originally as a four-function calculator. So we had 19 keys to play with, so each key had to serve at least two and usually three separate functions.

Tim: I had heard that because of the membrane keyboard, that people weren't going to do a lot of typing on it. And that was possibly one of the design considerations for using a command-key arrangement.

Nigel: That's possible. But I'd be surprised if there wasn't a connection between that keyboard and the way we crammed a great deal onto keyboards previously. And in fact, from a programming point of view, with the designer's, it's probably easier to recognize first of all that a shift key has been pressed and recognize that keys have been pressed after that, and that it is a whole command rather than to recognize a sequence of individual characters. The syntax checking--I don't know where that came from, but in retrospect it's the sort of thing that would fall out if you encouraged whoever was doing the programming to look at the way that calculators had worked. I mean basically, if you enter an illegal character sequence into a calculator, whatever that may be--two decimal points following one another, it will

recognize it immediately. Its a clever idea. It was a feature that was much appreciated in the machine. My guess is that it sort of just dropped out of the design criteria.

Tim: Here in the U.S., our major contact with Sinclair was through Timex and their mass marketing. Timex brought out the TS1000, and then the TS2068 for a short time, which was based on the Spectrum design. I had heard that Sir Clive made a comment that Timex had "fouled up" his Spectrum, in a well published statement. Did he actually believe that Timex had messed up the Spectrum design?

Nigel: Well we had high hopes for the American market. By the middle of 1982, Sinclair was actually deriving more of its revenue, more of its sales and profit, from the U.S. than the rest of the world put together. Even though in the States we'd been selling the ZX80 while the rest of the world had the ZX81, we'd been selling the ZX81 for a few months while the rest of the world had the Spectrum. So we had very high hopes for the American market, but they clearly depended upon going retail. We felt that our name was unknown to the major retailers in the States. We had no sales force. We had no experience in managing/motivating a sales force in the States. And so we decided we needed to find a partner who knew that. And Timex clearly knew and understood the product. They had been manufacturing the ZX81 for us as a sub-contractor, and they had a lot of sales people calling on every conceivable type of account selling watches and everything else. In some respects I think that we looked at Timex and said "well, at least thank God that they were there, and we weren't", because frankly, we would have lost our shirts in '83 with whatever our strategy would have been in the States. The market was out of control of any individual manufacturer, and it was marketing in

**NEED
A
PRINTER?
WE CAN HELP!**

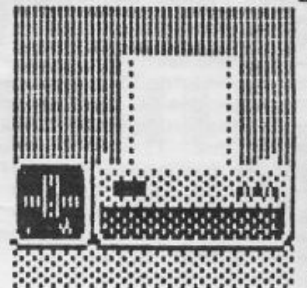

RMG can supply many top brands at low prices. Names like: CITIZEN-STAR-ALPS PANASONIC-OKIDATA-EPSON-SEIKOSHA BROTHER AND MORE!

***** CHECK THESE OUT! *****

| | |
|------------------------|---------------|
| PANASONIC KX1080i | ONLY \$175.00 |
| PANASONIC KX1091i | ONLY \$199.95 |
| STAR NX1000 MULTI-FONT | ONLY \$180.00 |
| STAR NX1000 RAINBOW | ONLY \$239.95 |
| STAR NX2400 24-PIN | ONLY \$339.95 |
| SEIKOSHA SP-180AI | ONLY \$159.95 |
| CITIZEN 120D | ONLY \$159.95 |
| CITIZEN 180D | ONLY \$175.00 |

Please add \$15 each for sh. & ins. We also have MANY used printers in stock-write or call!



RMG ENTERPRISES



1419 1/2 7TH STREET
OREGON CITY, OREGON 97045
503/655-7484 * NOON-10 TUE-SAT

NIGEL SEARLE

which everyone was guaranteed to lose money no matter how intelligently they handled themselves. So Timex took the brunt of that. I think that Timex might well look back at the situation and say to themselves "boy, I wonder if Sinclair really knew enough about the business to anticipate what was going to happen and lured us into taking the brunt of it". You know, if I was in their shoes, I might think that. But I think that at times, Clive would agree, and I believe he made comments to this effect (regarding the Timex TS2068), and he had a considerable sympathy for Timex that they got into a business which looked as though it would be very very profitable for both of us, and turned out to be otherwise. Having said that, there were certainly times when both Clive and I thought, and anybody else who was involved thought that Timex was not helping itself as much as it might have done. I think for example, Timex was right to hire some senior management to run its computer business. You didn't want the business to be run by a guy who's primary concern was designing, making, and selling watches, because the computer business would seem to him to be a relatively small business initially and perhaps wouldn't get enough attention. You needed to have people in Timex who didn't have anything to do with watches, who's lives depended on the computers being successful. But what they did was to build up an entirely separate organization, and they didn't make use of all the expertise they got out in the field of selling. The reason was, "well the guy who is a watch buyer isn't the computer buyer". I always felt there must of been some way that they could use their leverage as a major supplier of watches to department stores and drug stores as a way of opening the doors and having the right influence in getting the product out. And maybe they did to some extent, because they were pretty effective in getting the product out. But, yeah I think they did a lot of things that--I mean they spent a lot of time screwing around with the Spectrum and redesigning it, and by the time they had done it, I think that they had got a machine which was better than the Spectrum in many respects, but it was a lot later. So whether the 2068, when they got it was better than the Spectrum would have been, when they could have had the Spectrum, was certainly debatable.

I remember Clive's reaction to the TS2068, was that he thought it was a pretty neat design. So much so, that--the QL was at a stage of development where we were beginning to think about exactly what it should look like. The guy who was given the job of designing the appearance of the QL was given a 2068 with instructions to take a close look at it and see what could be learned from it. And I think the QL owes something to its design, to the 2068. That was something that Clive, as I recall, encouraged.

Tim: There was some talk about an expanded TS2068 with more memory, bank-switching, and some sort of higher operating system. There was also a rumor that Sinclair engineers were working on an advanced Spectrum with technology which would be shared with the Timex organization. Were you aware of any such project?

Nigel: To the best of my recollection there wasn't. There weren't projects within Sinclair to develop the Spectrum further. It was a constant topic of conversation after the QL design was well under way, as to whether we should attempt to replace the Spectrum with anything. We eventually approached the problem by saying "what is the worst thing any competitor would do that would hurt our sales of Spectrum computers?" And we decided that the greatest weakness of the Spectrum was the keyboard. And I think this must have been 1984, because I think the QL was already launched, was already in production. So what we decided to do very simply was to design a new case for the Spectrum. That became the Spectrum Plus. And all we were doing was designing a new case so that production would literally switch over as soon as the case became available, and the same printed circuit board and everything else would go into the case. That turned out to be a very key move in maintaining our market position and maintaining our margins, because we were able to charge more for the Spectrum Plus, or at least we were able to go on

charging what we'd been charging for the Spectrum. Otherwise we would probably would have had to lower the price.

And so I remember that decision being made very late in the year; a big rush to get that out before the end of the year. We'd been pretty much immobilized. Nobody could decide exactly what to do about the Spectrum, although there were lots of ideas around. But it was much later, probably in 1985 before any work really got underway on the 128K Spectrum and products like that.

Tim: At a recent Timex Sinclair user group meeting in New York, Billy Skyrme, who was the former head of Research and Development at Timex, now with Psion, described a computer called the TS3068 which was slated for production. Was this pretty much an "in-house" Timex design?

Nigel: Yeah, I'm pretty sure it would be.

Tim: Someone just suggested that Sinclair engineers were working on the design with Timex, but to your knowledge, that wasn't the case?

Nigel: We did have one engineer within Sinclair who was appointed specifically as a liaison with Timex. Timex may have asked his advice about things, and he may have played around with and looked at the

"I wouldn't be totally amazed if I'd woke up in ten year's time and found that the product had both their (TIMEX and SINCLAIR) names on it."

feasibility of some things like that. But it certainly wasn't something that we were working on.

Tim: Incidentally, Timex is still fairly committed to secrecy over a lot of things that they were working on. At the same user group meeting, Billy Skyrme mentioned that he could only tell (the group members) about a few things, but that a lot of information couldn't be divulged because of contractual agreements.

Nigel: Hmm. Well Timex did have some surprising projects going on. (a bit of silence) I mean I probably shouldn't mention some of the things for the same reason, because I don't know what they are doing with them today, but let's say that one of the attractions of Sinclair and Timex, was that Clive's always been interested in "miniaturization". He's launched at least a couple of wrist-based products. A wrist calculator that's not a watch, a digital watch, he had a watch radio. So at least three products now, I think, that were worn on the wrist. And Timex, and so far as it is a watch company, and certainly understands that people may want things on their wrist that do more than just tell the time. Timex has already produced calculator watches, and they have a watch that has a lot of timing functions and so on, which has been the best-selling single model of a watch for a couple of years in succession.

So both Clive and Timex have somewhere down the road in their minds, a sort of "Dick Tracy" type thing with a television, and a telephone, and everything else built into it, that you still wear on your wrist.

Tim: This is still something that they (Timex and Sinclair) are working on, not just a conception, but an actual product?

Nigel: I mean it's...you know, if I fell asleep now and woke up in ten year's time, I wouldn't be surprised to find either the Sinclair or the Timex name on a product like that. And I guess despite the past history that Timex and Sinclair's relationship

has not been a mutually profitable one, I guess that I wouldn't be totally amazed if I'd woke up in ten year's time and found that the product had both their names on it.

Tim: Is Timex still producing computers with Sinclair technology at this time, or have they scrapped all of that?

Nigel: Timex? As far as I know, Timex is not doing any computer work at all. As far as I know. But I guess I wouldn't know if they were.

Tim: Do they still have the rights to Sinclair technology, or has the sale to Amstrad taken that away?

Nigel: I'm pretty sure that the licensing agreement between Sinclair and Timex has expired by virtue of Timex's not offering any products for sale for a certain period of time, the agreement would just terminate itself under those circumstances. So I think that when Clive sold the rights to Amstrad to the personal computer stock, that would have included the rights which had formally belonged to Timex.

Tim: Let's turn to the QL. You had a lot more "hands on" with the QL project, than perhaps the ZX81 and Spectrum. What was your role in the development of the QL?

Nigel: Mostly sort of conceptual. Originally the QL was designed to have a built-in screen utilizing Sinclair's flat cathode-ray tube technology. And it was originally conceived to have a built-in modem. Some of the things that I remember about it...you know, obviously the flat screen got dropped simply because that technology was not going to be manufacturable in the time scale. The decision to use the 68000 chip was made pretty early on. And although we sort of wavered over that a number of times, the situation as I recall it is, that basically the engineers who were going to work on the design of the machine, both from a hardware and a software point of view, would have had extremely little enthusiasm for using anything other than the 68000. They saw the 68000 as being the state of the art microprocessor. And I suspect that we may have lost some of those people to other companies, while they would have had the opportunity to work with the 68000. And I think that everyone would have agreed that it didn't necessarily enable you to do anything that you couldn't have done with others, particularly because we were using such a minimal version of the 68000, the 68008. But in the long term, it gave us an upgrade path as well. Had the QL been more successful you might be seeing a QL today with a 68020 or even a 68030 in it.

The software that Psion designed for the machine was pretty radical at the time, and that was something that I was involved in, certainly the idea of having that software built in. It was something that I instigated with David Potter of Psion.

I had been shown, in confidence, an early version of GEM from Digital Research, and it was one of those situations, where it confirmed something that I'd already been thinking. I'd had this idea which to me at the time was an original idea, but I probably, you know, read it when I was half asleep sometime--stole it from somebody else. But when I saw GEM, I knew that it was right. The idea was a really radical one at the time, and it was the idea that you should have a spreadsheet which from a user interface point of view, looked just like a word-processor or the database. In other words, all the time that you spent learning to use the spreadsheet, shouldn't be wasted when you wanted to use the database program. You should see similar things on the screen. The F1 key should do the same thing, the F2 key, everything should be, the whole user interface should be as mapped as closely as possible. And that was, in my mind, the most significant thing we were doing with the software from Psion, was not simply that we were offering a set of programs like that, but that they all worked in a similar way.

Tim: I have to ask you this. There was an interview with Sir Clive a while back, and the statement was

made by Clive that he wanted to use the Z80 processor in the QL, and that it was your persuasion that changed his mind to use the 32-bit processor, and now (looking back), he wished that he had "stuck to his guns", rather than listening to you. How do you feel about that statement?

Nigel: Well, Clive's had a love affair with the Z80 for a long time, as evidenced by the Z88 computer. He's very impressed with the fact, that for a mere dollar or so, you can buy this incredibly powerful microprocessor, which the Z80 certainly is. He also, at one time, had a love affair with the 68000. And he and I visited Motorola, I believe in January of 1982 in Phoenix. And we had some very high-level meetings with people in Motorola. And Clive was very much convinced at that time, that the 68000 would be the way of the future, and was very taken with the idea, that he and his company would be leaders in using the 68000. That's not to say that he didn't subsequently decide that the Z80 after all was much better. I think that maybe he got married to the Z80, and had an affair with the 68000, and then he went back to his "wife".

And certainly, as far as the QL was concerned, I don't think it was my idea originally to use the 68000, but I think that we did go back and forward, and we considered using other processors including the Z80. When ultimately the decision was made, Clive is probably right, he probably said to me eventually, "look, your running the company, your working with the guys who are going to work on this project, you decide". And it's possible in that sense, that he chose to let me decide, or he listened to my arguments, and was even persuaded by them, or thought that he ought to not be making every decision in the company on things like that. I have no doubt whatsoever though that both from the point of view that had the QL been successful, it would have given us an upgrade path, and from the point of view of

??

GIFT TIME IS HERE AGAIN!



RMG wishes to show our gratitude for the continued support of TDM readers by offering a SPECIAL XMAS DISCOUNT on ANY disk system in our regular line. If you get your disk system order in to us BEFORE 12/15/88, AND include a copy of this ad, you will receive an added **10% DISCOUNT** off our already LOW prices! Includes AERCO or LARKEN SYSTEMS. If you have a catalog and wish to order, just fill in the order form and deduct 10% from the item price ONLY! THEN ADD THE SHIPPING. DON'T WAIT! SAVE UP TO \$40 TODAY!

 **RMG ENTERPRISES** 
 1419 1/2 7TH STREET
 OREGON CITY, OREGON 97045
 503/655-7484 * NOON-10 TUE-SAT

??

(NOT VALID WITH ANY OTHER SPECIAL)

NIGEL SEARLE

motivating people to work on the project. I do not believe we could have gotten really good people working on a Z80 project.

I have talked to Clive about it more recently, and I certainly expressed my view to him that the "Achilles' Heel" of the QL was the Microdrives. Maybe he just chooses not to argue with me about it any longer (laughs). But obviously as I say, he still has a pretty strong feelings about it. I'm sure that the use of the Z80 in the Z88 is not some sort of accident, it's there by design.

Tim: In another interview, more recently than the one I just mentioned, that he (Sir Clive) feels that since disk drives are mechanical, and that all mechanical things will eventually be replaced by solid state. I personally don't see this occurring for some time, of phasing out disk drives, hard drives, drives of any type. Why is it that he has always been "anti-disk drive"?

Nigel: (pause) I don't know. I think it is a (another pause)...I don't think that he is just anti-disk drive because it's a mechanical device. The Microdrives are a mechanical device as well. A disk drive is always going to make a machine more expensive, because of the mechanism that's gotta be

"But I believe he is still working on... what we would call today, a SUPER COMPUTER..."

built in there. It's gonna have some speed problems because there isn't equally instantaneous access to all parts of the drive. Disk drives are going to have the advantage of the media being very, very cheap. But ultimately, I guess there is no reason why solid state can't be very cheap too. And Clive is, in many respects, more of a semi-conductor person than a computer person. One of the reasons that he's been able to design some of the products he has at very low cost, is that he's been able to take advantage of what the semi-conductor industry's producing and sometimes use it for purposes that it never intended. And he has a very good, very deep understanding of what's going on in the semi-conductor industry. And I think he believes that one of these days, in sufficient volume, the semi-conductor industry will be able to churn out a 10 Megabyte chip cheaper than a, or very close to, as cheaply as you can produce a 10 Megabyte disk.

Tim: Jumping to the Z88 portable computer--I remember about a year ago speaking with you on the phone about your impressions of the Z88. At that time, you felt that the machine was "a little late" in retrospect of the portable computer market. And then here, many months later, I find out that you are a key figure in marketing the machine here in the U.S. Why did you jump on the Z88 "band wagon"? Did Clive give you an offer that you couldn't refuse?

Nigel: No (pause) I think that the Z88, and I want to be careful about what I say, because I have some knowledge of the company's future plans and I don't want to give them away in any sense.

Sinclair Research as a personal computer company eventually became a company that did over 100 million pounds of business in a year. Then the exchange rate was over 150 million dollars a year. It certainly couldn't have done that without the ZX80. The ZX80 was a successful product given what it was. But we sold a few tens of thousands of them world-wide, and it took us over a year to do that. Later on we sold twice as many Spectrums in a single month as we'd ever sold ZX80's in a whole year. So the ZX80 was a "launching pad". And I guess my feelings about the Z88 are somewhat similar. I think it will find a

market. I think it will be successful. But it will be a limited market. We're not going to sell millions of Z88's. I think that if the company remains committed to the portable market, and looks at what it can do in the form of a Z89, and the Z90, and the Z91. And makes the same sort of progress that it made in going to the ZX80, to the ZX81, and to the Spectrum, and to the QL, then I think we can sell millions of portable computers. So, if I'd thought the Z88 was the end of the design line for portable computers, I'd say its got a limited life--its going to be overtaken by other manufacturers products sometime in the next 24 months. But as long as it's the company's intention to itself overtake the Z88 and these competitors with one or more new products, then there's a real future there.

Tim: So Clive is working on other laptops?

Nigel: (smiling) I hope so.

Tim: OK.

Nigel: I hope so, because I mean not because I think the Z88 is the only portable computer that's really small enough to carry around with you wherever you go at the moment, and it will remain that way for maybe another year, with luck maybe a little longer. But ultimately somebody's going to bring out a product that will obsolete the Z88, and the objective in this business is to make sure that you obsolete your own product before somebody else does it. So I see the Z88 as very akin to the ZX80. It's a terrific first product in the category, but I think that category is going to be very competitive fairly quickly, and we'd better be doing something--a major step forward, to remain competitive.

Tim: That's sort of ironic, because the ZX80 was a \$200 computer, and the ZX81 was a \$100 computer, but with the Z88 you have a \$500 computer that people are sinking a good deal of money on, and then you release another product--the Z89 for such and such a price. That's going to be a little harder for people to swallow when the new product comes out.

Nigel: That's always been a tough problem in the computer business, and I just don't know what the answer is. I mean, would we make everybody happier if we don't bring out any new products? Or if we bring them out and charge twice as much for them? I don't see any alternative. The products that are possible and the prices that are possible, are dictated by the underlining technology. And that is available in more or less equal measures to everybody, including ones competitors. If we can bring out a ZX81 that was less expensive than the ZX80, there's a good chance that somebody else would have done it. In fact, Commodore announced a couple of machines in that sort of price range at a Consumer Electronics show one year, then didn't bring them out. Probably because they wouldn't have been competitive with the ZX81. I think that you've got to decide when you buy a product whether its worth what your paying for it now. I mean people payed \$2000 for the first VCR. I payed \$999 for one of the first TRS-80 computers from Radio Shack with 4K memory and an integer-only BASIC.

Tim: How soon do you think another computer product will be released, given a frame of time?

Nigel: I'm not prepared to say...I really can't say.

Tim: I have just a couple more questions. Is there another computer product, not related to portables, coming out, or is the portable-thing consuming all of Clive's time right now?

Nigel: Clive has had an interest for a long time in computer design. And I don't know much about this. But I believe he is still working on, with a long term objective of producing what we would call today, a "super computer", with some degree of parallel processing, large amounts of memory, and probably a custom processor.

Tim: A "mini-Cray"?

Nigel: A "mini-Cray". Yeah.

Tim: My final question is, overall, working with Clive Sinclair and looking to the future, is it exciting? I mean it must be a lot more interesting than your average "paper-shuffling" job?

Nigel: Oh yeah, it's certainly exciting. I suppose the excitement comes from knowing that at any moment almost you could be part of truly explosive growth.

We started Sinclair Research in the States to sell the ZX80, and we sold, I forget how many ZX80's altogether, but over a period of a little more than a year, we sold quite a few. Twenty thousand maybe. And in the fall of 1981 we started selling the ZX81, and by the end of the year, we were doing over half a million dollars worth of business a week. And we literally went from virtually zero. The ZX80's had stopped selling because the ZX81 had been launched in England, and we got the ZX81 available in the States eventually approved by the FCC and everything. And we just overnite went from a small office employing two people with hardly enough to keep us busy all day, to where we were receiving several hundred orders a day. Running at an annual rate of 25 to 30 million dollars. And yeah (laughs), that's pretty exciting.



**Bottle Cap
Software**

Presents

Graphit-1

First in a series of TS2068
Information Charting Programs

Personal Monthly Sinclair
Gaming Usage per month
starting with July 1986.



Graphit-1 features:

3 times as many input values
as Quadra-Chart.

3-Dimensional bar graphing.

Plot data points with connect
points option.

Copies to TS2040, full size
printer w/Rerco I/F, or others
w/your custom driver.

SAVE SCREEN\$ and/or DATA().

Status Menu Driven Program
requires Joystick or compatible.

Cassette version easily changed
for your disk system. Larken
version is available.

All Bottle Cap Software is \$5.00
plus \$1.00 s&h. Send checks to:

Bottle Cap Software
1284 Brushwood Ave.
Cincinnati, OH 45224

Lemke Software Development
QUALITY PRODUCTS FOR THE TS-2068

Join the world of Desktop
Publishing with the
Pixel Print Professional!

| | |
|------|----------------------|
| v3.2 | Aerco Disk Version |
| v3.3 | Cassette Version* |
| v3.4 | A&J Microdrive* |
| v3.5 | Oliger Disk Version* |
| v3.6 | Larken Disk Version† |

* NOTE: these versions require
at least a 32K RAM cartridge
for BANK-SWITCHED memory.

† NOTE: the LARKEN version
needs at least a 64K RAM DISK
memory expansion.

Lemke Software Development
2144 White Oak
Wichita, Ks. 67207

Pixel Print PLUS!.....\$19.95
(BASIC DESKTOP PUBLISHER PRG.)

Pixel Print

Professional!.....\$29.95

(SEE ABOVE, W/BANK-SWITCHING
FOR FULL-PAGE DESIGN/PRINTING)



Masthead Package #2
30 Great Graphics!!

(30 GREAT, EYE-CATCHING PICS
TO REALLY ADD 'CLASS' TO YOUR
DESKTOP COLUMNS! JUST LOAD
THEM INTO THE DTP... ADD TEXT)

Masthead Package #2....\$14.95



32K
RAM



32K
RAM



32K
RAM



32K
RAM

(32K RAM EXPANSION CARTRIDGE:
VOLATILE MEMORY, PLUGS INTO
CARTRIDGE DOCK. NOT LIMITED
TO USE WITH THE DTP.)

32K RAM Cartridge.....\$44.00

(WITH THE PURCHASE OF THE
PIXEL PRINT PROFESSIONAL...
PURCHASED SEPARATELY, \$47.95)

1989 Personal Calendar PLUS!

(LOAD INTO ALL VERSIONS OF THE
PLUS! AND PROFESSIONAL. ADD
FAMILY BIRTHDAYS... AND MORE!)
COMES WITH 80 CUSTOMIZING HIGH
RES. ICONS! CALENDAR COVERS A
14 MONTH PERIOD, JAN '89 THRU
FEB '90!)

====ONLY \$19.95====

**FANTASTIC FONTS! --- THEY'RE
HERE!!**

(16 POINT FONTS ARE DONE AND
READY TO SHIP! 12 8X16 FONTS
ONLY \$14.95, AND 6 16X16 FONTS
ALSO ONLY \$14.95) **FREE CATALOG**

SYD WYNCOOP

THE PROGRAMMING CORNER

PROGRAMMING
PROBLEMS

PROGRAMMING
ADVICE

Write to Syd Wyncoop, c/o TIME DESIGNS, 29722 Hult Rd., Colton, OR 97017. Syd specializes in Timex/Sinclair (1000/1500 and 2068) BASIC, Machine Code, CP/M; and is also experienced in disk operating systems, other computer languages...and MS-DOS(IBM). Even if you are a beginner or an advanced programmer, why not write to Syd? That way, we will all learn something.

- The Editor

I have just purchased a complete LARKEN disk drive system for my 2068 and I am wondering if I made a \$497 mistake. I have read in various Timex Sinclair publications where problems are encountered in converting programs from tape to disk. I have very little programming experience and no one in my area to assist me.

Dennis Silvestri
256 Lloyd St.
New Haven, CT 06513

Dear Dennis,

You have raised two very important points. The first, is the importance of a user group, and the support that group can provide. I urge any readers in the New Haven area to contact Dennis. Without belaboring the point, I cannot stress strongly enough the importance of a support group, even if only a few members are in the group.

The second point is usually explained in the documentation provided with the disk system. Having said that, I must confess that I find most documentation to be woefully lacking.

The LARKEN disk system uses the command:

```
RANDOMIZEUSR 100
```

This command initializes the disk drive system and is followed by the disk commands. For example, suppose you want to LOAD a BASIC program from disk. The complete command would be:

```
RANDOMIZEUSR 100: LOAD "program.b1"
```

An explanation of the ".b1" can be found in the LARKEN manual. Unfortunately, I do not have a LARKEN system, or a copy of the manual, but I believe this command structure to be correct. I can say that other than supply delays, I have never heard of any problems with LARKEN or their products.

The simplest method to learn disk commands is to make a list. Divide a sheet of paper in half and label one half "tape" and the other half "disk". Now, write a tape command under the heading "tape" and start searching your disk manual for the corresponding disk command. After you have found and tested the proper disk command, write it on the other half, under the heading "disk" and immediately across from the tape command. Continue in this manner until you have determined all the needed commands. Keep this sheet with your disk manual for future reference and add all new commands or their variations to the list, as they are encountered.

The next item you will need is a tape header reader. There have been several published in Timex magazines. This utility will be needed for saving machine code or other binary memory images to disk. It will give you the start address and length of the machine code.

Lastly, there will be a few programs which use fast loaders and headerless files. These will be very difficult to move from tape to disk, as they will require extensive assembly language experience.

- Syd

I have a 2068, AERCO FD-68 disk drive system, AERCO CPI, AERCO RS-232, CP/M(RPM) and a 2050 modem. Do you know how I can learn to program in Machine Code? I have a copy of HOT-Z.AROS. Do you know if anybody has modified TECH DRAW JR for the AERCO disk system?

Bill McKelvey
Wall, New Jersey

Dear Bill,

You have asked a lot in very few words. Your first question, on Machine Code, is an area that has been taught in TIME DESIGNS, as well as several others. However, the best method to learn Machine Code is to have a task you absolutely must do, a good instruction book and a friend you can ask questions. Then, start the task and do not quit until it is done. I guarantee you will learn Machine Code by the time you complete this process. While this may seem to be a rather stiff answer, I firmly believe it is the best answer.

Machine Code is not so difficult that you cannot learn it, but there is a definite learning hurdle to be overcome. HOT Z.AROS is an excellent tool, but it is difficult to learn to use. I suggest the ZEUS ASSEMBLER for beginners. Zeus will permit you to concentrate on the task of learning machine code, without the additional overhead of learning a complicated program.

I assume your question concerning machine code is prompted by your desire to convert TECH DRAW JR to disk. If this is true, you are tackling a difficult first task. TECH DRAW JR can be easily moved to disk, the code address is 30036 and the length is 35400. You have only to change the BASIC tape commands to disk commands. The changes necessary to the BASIC loader, in order to move the program to AERCO disk are:

```
Line 50, change the LOAD command to  
CAT "TDRAW.BIN",  
Line 9910, change the SAVE command to  
MOVE "TDRAW.BAS",10  
Line 9920, change the SAVE command to  
MOVE "TDRAW.BIN",30036,35400
```

TECH DRAW JR is written to work only with tape. However, in order to change that, which I assume to be your real goal, you must disassemble the machine code and find the area that deals with the tape commands. You must then change this area to branch to your disk command routine. I have written to the publisher of TECH DRAW JR, Zebra Systems, in search of this information and will publish any response I receive.

I wrote a checkbook program that worked perfectly until the last time I used it, and then something went wrong. I store my entries in DIM-ensioned arrays. To get a print out, I enter the first number to start the list at, and then use a FOR/NEXT loop to do the printing. I have an input line that gets this number from me. Following that line, is one that prints out a sentence followed by the input variable. The last time I tried this, the program broke out with a "variable not found" error message. I do not know what caused this to suddenly happen but whatever it is, it's saved with the program.

James Brezina
Elmhurst, Illinois

Dear Jim,

Your letter is a little too brief for me to make an exact determination, so I will have to guess. It would appear that the variables area of your program has been partially "trashed". This would account for the fact that the problem is SAVED with the program, as the entire variables area is saved along with the BASIC program. The simplest fix is to go back to the last copy of the program that worked properly and re-enter all data after that copy.

I am assuming that there are no bugs in your program that have caused the difficulty, as you stated that you had used it for a while and it worked well. Therefore, the solution to your problem most probably is tied to some recent change you made in either the program or a hardware addition. You will need to conduct a thorough search for conflicts that may have caused these changes.

As an example, one of the most common causes of conflict is printer driver software. Check to be sure it is not LOADING over-top of the tail end of the variables area. You could be inadvertently destroying some of your variables upon loading the printer driver software, especially if your dimensions are large and approaching RAMTOP. Have you properly reset RAMTOP? Also, is it a good copy of your driver software? A poor copy may work and appear fine, but could be overwriting the variables area.

The bottom line is that this is one of those elusive problems that can come and go, and be most difficult to track down. A systematic approach beginning from the last known trouble-free point will eventually find it though.

- Syd

□□□□□□□□□□□□□□□□□□□□

BACK AGAIN... FROM A*B*B*A SOFT

Don't File Your 1988 Tax Return
UNTIL YOU HAVE

QWIK-1040-88

The LARGEST SELLING T/S 2068 Income Tax Program in America

INCLUDES: Form 1040, 1040A & EZ,
Sch. A, B & R * Forms 2106, 2441
Automatic Calculation Income Tax
Liability, Child Care Credit Tax-
able Social Security, Earned In-
come Credit * Multiple W-2 & 1099
Entry * 2040 Compatible * More

THIS YEAR SCH C and SE Included!

Only \$29.50 Postpaid
-1st Class Mail-
For Timex/Sinclair 2068 Computer

QWIK-1040 is an "interview type"
program. It will calculate your
allowable IRAs, Interest and De-
ductions accurately, without the
use of cumbersome input sheets.
CALCULATION OF TAX LIABILITY AND
CREDITS IS AUTOMATIC!!!

This program was designed with the taxpayer in mind. It is easy
for you to accurately prepare your own income tax return EVEN IF
YOU HAVE NEVER DONE IT BEFORE! It is also sophisticated enough
to be used to prepare returns for others, with or without exper-
ience. An ideal teaching tool for tax and accounting students.

**SPECIAL: IF YOU PURCHASED
1987 QWIK-1040 FROM A*B*B*A SOFT
TAKE A FULL \$10 DISCOUNT.**

The 1987 QWIK-1040 is STILL AVAILABLE for just \$12 POSTPAID.

Send CHECK or MONEY ORDER (U.S. Funds)/Mid-January Shipment Date



HERB BOWERS, Sr.
2588 Woodshire Circle
Chesapeake, VA 23323
Phone: 804 487-5924

PROMISE LAND ELECTRONICS

Dan Elliott, Owner

*Servicing COMPUTERIZED
electronic equipment*

COMPUTERS / MODULES / PRINTERS / MONITORS

Sinclair QL TS-2068 TS-1500 TS-1000

16K Ram Pack ZX-81 Memotech Modules

Commodore 64 VIC-20 PLUS-4 C-16

Coleco ADAM TI-99/4A Commodore 128

REPAIRS / UPGRADES / ASSEMBLING / TESTING

Write for prices:

Dan Elliott

Route 1, Box 117
Cabool, MO 65689

Ph. (314) 739-1712 evenings, Sunday - Thursday.
Ph. (417) 469-4571 weekends.

UPDATE!



Supporting the Sinclair QL, Z88, and TS-2068
Subscription \$15.00 Year. UPDATE Magazine,
1317 Stratford Ave., Panama City, FL 32404

TS Communique

Joe Williamson

YOUR HARDWARE PROBLEMS EXPLORED



Send a description of your computer hardware problems to the TS COMMUNIQUE, c/o TIME DESIGNS, 29722 Hult Rd., Colton, OR 97017. Joe Williamson will discuss and possibly offer a solution for your TS1000/1500, TS2068, QL, and associated peripherals. Joe is the owner and operator of a successful electronic and video repair service in Gainesville, Florida; and a bonafide Sinclair computer enthusiast.

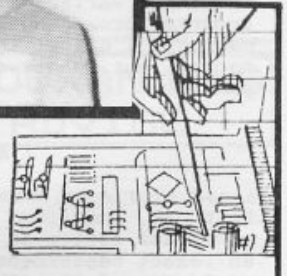

Can the MW-100 Mindware printer be used on the 2068 computer? It was originally used on the TS-1000 printing 16 columns wide.

Andrew Jubb

Dear Andrew,

That mindware printer connected to the TS-1000 in the same way the 2040 printer did and although I haven't tried it on the 2068, I don't see any reason why it wouldn't unless it requires the 9 volts that appears on pin four, bottom side of the rear edge connector and can easily be supplied. Good luck! -Joe

From reading one of your TS Communique replies, I gather that you have a Sears TV/Monitor/RGB, as I have. Mine is Model C539-14544, which may be slightly different than the units sold in the USA.

Normally I use it with my TS2068. However, on occasion I use it with my ZX81. That's when I encounter a problem. It works perfectly except when I load a program from tape. When I do that the screen rapidly turns black, and stays that way until loading is completed.

I have attempted to cope with the problem by using separate patch cords in the computer and TV, laying them close together, thus getting a capacitive coupling effect. However, this results in a snowy picture when running the program. Any ideas?

George Chambers
Scarborough, Ontario

Dear George,

The Sears monitor has a mute circuit in it that mutes the picture when no sync or improper sync is detected. It is in there to help protect the set from damage. During the LOAD/SAVE operations, the monitor "sees" the black bands as improper sync and mutes the video. You can disable the mute function, but that may cause problems down the road.

The mute also works in video and RGB mode, so if you experiment with connecting your 2068 to work with RGB, and have no picture, it is most likely due to poor sync. -Joe

How would you construct an interface to drive one of those monitors sold by BG Micro? I'm talking about the type of TTL CRT that would require you to take the NTSC signal from the 2068 and split it out to drive these monitors.

John Shepard
Coldwater, MS

Dear John,

Until just recently I had always assumed that TTL monitors worked just like RGB monitors but with just one luminance signal instead of three color signals. Vertical and horizontal sync are separate on TTL monitors and alot of RGB monitors although most have composite sync inputs as well.

I recently had a friend ask me to take a look at his IBM TTL monitor which had a bad fuse in it. After it was back in working order, I decided to see how it would work on my 2068. To make a long story short, it didn't work! Apparently the TTL Monitors operate at a different scan frequency. If anyone has had success at connecting one of these monitors, let us know! -Joe

I recently purchased the Hacksel centronics interface for the 2068 and I am attempting to use it with a Radio Shack DMP 105 printer.

After loading all three codes (LPRINT, COPY, and HI-RES COPY), I can enable various print sizes (bold, elongated, etc.) when using MSCRIPT but have been unable to utilize them in BASIC programs, getting a standard print character regardless of the code sent (using LPRINT CHR# xx).

The instruction sheet from RMG Enterprises says that the copy routines will work with an Epson compatible printer (not mentioned in the advertisement), which I guess the DMP 105 is not as I have been unable to make any screen copies. Each time I do, I get an "Integer out of range" error.

I have seen screen dumps of graphs made on the DMP 105 using a centronics interface so I know the printer is capable of this. Any assistance would be greatly appreciated.

William Haines
Schenectady, NY

Dear William,

By far the most popular printer standard is Epson, so most are Epson compatible, although this isn't really saying much as most printers have their own idiosyncrasies anyway. The DMP 105 claims to be IBM compatible and should mean that it is Epson compatible since Epson caters to the IBM market.

I believe that the Radio Shack printers are made by Seikosha and the software should be configured to this brand if that option is available. LPRINT and LLIST should work on just about any printer, Epson compatible or not. The differences come in when graphics are concerned. That is where all the variations exist - think about how long it was before anyone came up with a COPY routine for the Olivetti Inkjet printer!

If you don't have any options in your software, try different software like Zebra's Zprint 80 which does support Seikosha printers. Also when calling for

different type styles from BASIC, most are double byte instructions. To set double width printing, you need to use: LPRINT CHR*(27);CHR*(14); or you could also use: OUT 127,27;OUT 127,14.

When using MSCRIPT, you don't need to load any extra codes as MSCRIPT already has them built into the program. I have had alot of letters about the DMP 105 and the problems associated with them, read on. -Joe

I have an interface problem involving my TS1000 and a Radio Shack DMP 105 printer. When using the Memopak centronics printer interface, the printer does not execute a carriage return when it reaches the end of a line of text. This occurs when using Word Sync II.4, Memotext, Memocalc or just the interface from BASIC using LPRINT.

The computer and printer work fine when using an Aerco CP-ZX interface, and the Memopak interface works fine when using a Gorilla Banana printer.

Referring to the DMP 105 control codes, the printer expects to receive carriage return (13d, ODh) at the end of a line. Perhaps you or one of your readers would know what to poke where to make these work.

Bob Barnett
Fort Myers, FL

Dear Bob,

It has been a long time since I've seen a Memopak but I recall there being dip switches in it to control various functions to the printer. Check and see if there is a linefeed/carriage return suppress switch available. Also, check the printer dip switches and try different configurations with them.

From the samples you sent, it appears that a line feed is being sent with no carriage return. Or, if the printer is bi-directional, something is keeping the print head from printing back the other way but this is not probable. Memotext itself may also have some dip switches you can try. Also try sending from BASIC: LPRINT CHR* (13) which should send a carriage return and line feed each time it is executed. Put that in a FOR-NEXT loop and try changing dip switches until the correct combination is found. This technique is called mad-dogging but works better than pulling one's hair out which is what this problem sounds like! -Joe

The article regarding the non-linearity of the 2040 printer appeared in the May/June '85 issue of TDM on page 12.

Here is a sample printout and a listing of the program which produced it. Maybe this information will help Don Balmer to solve his problem. His TV and/or printer may require some experimentation to find the exact correction factors.

Paul Synder
Chattanooga, TN



NO CORRECTION



CORRECTED FOR SCREEN;
HORIZONTAL DIMENSIONS
MULTIPLIED BY 1.13



CORRECTED FOR PRINTER;
HORIZONTAL DIMENSIONS
MULTIPLIED BY 1.23

```
200:PLOT 0,174: DRAW 54,0: DRAW
0,-54: DRAW -54,0: DRAW 0,54
202 LET C=27: LET R=25: FOR N=0
TO 2*PI STEP PI/90: PLOT C+R*CO
S N,147+R*5IN N: NEXT N:
210 PLOT 0,114: DRAW 54+1.13,0:
DRAW 0,-54: DRAW -54+1.13,0: DR
AW 0,54
212 LET C=27*1.13: LET U=25: LE
T H=U*1.13: FOR N=0 TO 2*PI STEP
PI/90: PLOT C+H*CO S N,87+U*5IN
N: NEXT N:
220 PLOT 0,54: DRAW 54+1.23,0:
DRAW 0,-54: DRAW -54+1.23,0: DR
AW 0,54
222 LET C=27*1.23: LET V=25: LE
T H=U*1.23: FOR N=0 TO 2*PI STEP
PI/90: PLOT C+H*CO S N,27+V*5IN
N: NEXT N:
230 PRINT AT 2,10:"NO CORRECTIO
N";AT 9,10:"CORRECTED FOR SCREEN
";AT 10,10:"HORIZONTAL DIMENSIO
NS";AT 11,10:"MULTIPLIED BY 1.13
";AT 17,10:"CORRECTED FOR PRINTE
R";AT 18,10:"HORIZONTAL DIMENSI
ONS";AT 19,10:"MULTIPLIED BY 1.2
3"
240 LPRINT " : COPY : LPRINT "
: LLIST 200
299 STOP
```

Dear Paul,

Thanks for finding that for us. That May/June '85 article was written by Dick Wagner of Canby, Oregon and covered several points on graphing different calculated functions. Joan Kealy also wrote in and said that Oleg Jefmenko also had an article out which I believe was in Syntax a few years back which is the article I remember seeing. I'm surprised Tim didn't remember Dick's article of a few years ago! -Joe

Dear Joe,

Guess the 'ol memory is slipping. I've heard that "early senility" is a complication that editors can contract. Meanwhile, Dick Wagner sent in these comments regarding non-linearity of printers. -Tim

Dear Joe,

Concerning Don Balmer's comments about the non-linearity of the TS2040 printer (large printers are not necessarily linear either) in your last TS COMMUNIQUE column, please refer to my article in the May/June '85 issue of TDM, entitled "A Graphic Problem for the T/S 2068". Paragraphs four and five comment on this.

My 2040 prints a rectangle taller than wide when I screen draw a square. What I am doing in this article is to multiply the X axis by 1.24 to make it print 24% wider. The COPY command makes this a square on the printer from a rectangle on the screen. For my Panasonic printer, the X axis is wider so I multiply the Y axis dimension by 1.18. Of course, the opposite axis can be divided by the same numbers, depending upon the desired final printed size.

Use the multiplier in the DRAW part of a program as DRRW 1.24*80,0 for a longer horizontal line, or DRAW 0,1.18*80 for a vertical line. This won't work for the CIRCLE command, so apply the same approach to the circle formula. Multiply the COSine part of the formula by 1.24 for the 2040 printer, or the SINE part of the formula by 1.18 for the Panasonic printer.

To calibrate a printer, print a large square on the screen and then COPY to the printer. Use a metric or decimal scale (preferred) to measure the printed image. The ratio of the larger dimension to the smaller (divide) will give the correction factor.

Keep up the good work on your TS COMMUNIQUE column. It shows that there are still many of us computer buffs who require help.

Dick Wagner
Canby, Oregon



GIVE A
GIFT SUBSCRIPTION
TO TIME DESIGNS



CATCH A DRAGON!

by Gregory C. Harder

ZX81/TS1000/TS1500

In the December 1983 issue of BYTE Magazine an article entitled "A Tiger Meets A Dragon" by Dan Rollins appeared. This article contained a program listing, written for a TRS-80 computer, which plotted "dragon curves" on an IDS PAPER TIGER printer. I have converted the program to plot dragon curves on a TS1000/ZX81 equipped with 8K static RAM, a 16K (or more) RAMpack, and the SCRAM HI*RES EXTENDED BASIC program. However, since there are not too many SHREB specific lines in the listing, it should be easy to convert to a TS2068, considering the similar resolution and screen formatting.

So what is a "dragon curve" anyway? A dragon curve is a regular fractal which forms from an infinitely repeated construction process. To quote from D. Rollins' article: "A method to generate simple low order dragons is to fold and refold a narrow strip of paper. Visualize a flat strip of cash register tape, as an order-0 dragon curve. Fold it once in the center, and you have an order-1 dragon. Bi-secting the tape by folding it "n" times, always in the same direction, will create an order-n dragon curve. Now unfold the tape so that the creases form 90-degree angles. The unfolded tape will have a pattern of left and right turns that wind around in seemingly random directions, a dragon curve."

Luckily, we don't have to understand the mathematics behind the process in order to enjoy the beauty of these curves. Incidentally, the dragon curve got its name from the resemblance some people see to a classic oriental dragon.

LOAD your SHREB program into your computer, then delete line two as we will not need the 64 character print routines. Be sure to POKE 18080,208 and POKE 18081,75. Enter Listing 1 and you have the completed dragon curve generator ready to RUN. Enable your SCRAM board before running.

The program will ask for several inputs before plotting the dragon, most of these are self-explanatory. SIZE is the order (number of folds) for the dragon curve. DIRECTION-REVERSAL-SEQUENCE is the direction of the folds (i.e., left or right). If you choose you can have the dragon automatically centered on the screen, if it will fit.

Once the dragon is finished, you will be taken to a menu of options. These again are self-explanatory. One interesting option is to run a new dragon without erasing the previous one. This will allow you to connect dragons together and create even more intricate patterns.

If you want to run the program on a TS2068, omit the IF USR HR THEN sequence, and all references to SLOW and FAST mode, etc. Also, change YM at Line 5070 to 176.

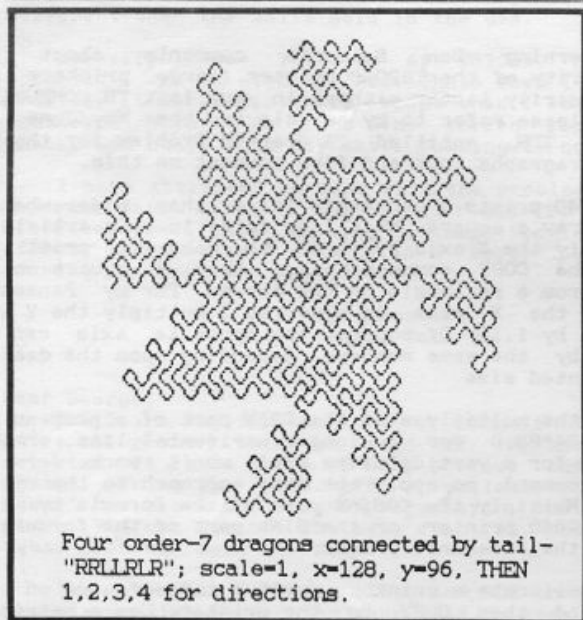

DRAGON GENERATOR SHREB VERSION

```

0 REM 8 456 SMC
1 REM FAST
2 GOTO VAL "SE3"
5 REM 507
10 IF USR HR THEN PLOT X,Y
20 FOR J=I TO LT
30 FOR K=I TO SC
40 LET X=X+X(D)
50 LET Y=Y+Y(D)
60 IF Y>0 AND Y<=YM AND X>=0
AND X<=XM THEN IF USR HR THEN PL
OT X,Y
65 IF INKEY$("<") AND F THEN GO
SUB VAL "1E3"
70 NEXT K
80 LET D1=D
90 LET D=D+(B$(J)="R")-(B$(J)=
"L")

```

```

100 IF D<I THEN LET D=N4
110 IF D>N4 THEN LET D=I
120 FOR K=I TO N2
130 LET X=X+X(D1)+X(D)
140 LET Y=Y+Y(D1)+Y(D)
150 IF Y>0 AND Y<=YM AND X>=0
AND X<=XM THEN IF USR HR THEN PL
OT X,Y
160 NEXT K
170 NEXT J
180 SLOW
190 GOTO VAL "8E3"
495 REM 507
500 FOR J=I TO N
510 LET IP=IP+I
520 IF IP>L THEN LET IP=I
530 LET B$(SP+I)=D$(IP)
540 FOR K=I TO SP
550 LET B$(N2+SP+N2-K)="L" AND
B$(K)="R")+("R" AND B$(K)="L")

```

```

560 NEXT K
570 LET SP=SP+N2+I
580 NEXT J
590 RETURN
695 REM 456
700 FOR J=I TO LT
710 LET SX=SX+X(D)
720 LET SY=SY+Y(D)
730 IF SX<XL THEN LET XL=SX
740 IF SX>XH THEN LET XH=SX
750 IF SY<YL THEN LET YL=SY
760 IF SY>YH THEN LET YH=SY
770 LET D=D+(B$(J)="R")-(B$(J)=
"L")
780 IF D<I THEN LET D=N4
790 IF D>N4 THEN LET D=I
800 NEXT J
810 LET XH=XH+(N4+SC)
820 LET XL=XL+(N4+SC)
830 LET YL=YL+(N4+SC)
840 LET YH=YH+(N4+SC)
850 LET XD=XH-XL
860 LET YD=YH-YL
870 SLOW
880 RETURN

```

```

995 REM TIME FLOOR
1000 IF USR HR THEN RUN
1010 IF USR HR THEN PAUSE XM
1020 FAST
1030 RETURN
4995 REM STAR
5000 IF USR VAL "19400" THEN CLS

5010 LET Q=NOT PI
5020 LET I=PI/PI
5030 LET N2=I+I
5040 LET N4=VAL "4"
5050 LET HR=VAL "19400"
5070 LET YM=VAL "191"
5080 LET XM=VAL "255"
5090 SLOW
5100 PRINT " DRAGON CURVE SE
LECTION "
-UP TO 13 FOR 16K?"
5110 INPUT N
5120 PRINT " "
5130 PRINT " "
5140 PRINT " "
5150 PRINT " "
5160 PRINT " "
5170 PRINT " "
5180 PRINT " "
5190 PRINT " "
5200 PRINT " "
5210 PRINT " "
5220 PRINT " "
5230 PRINT " "
5240 PRINT " "
5250 PRINT " "
5260 PRINT " "
5270 PRINT " "
5280 PRINT " "
5290 PRINT " "
5300 PRINT " "
5310 PRINT " "
5320 PRINT " "
5330 PRINT " "
5340 PRINT " "
5350 PRINT " "
5360 PRINT " "
5370 PRINT " "
5380 PRINT " "
5390 PRINT " "
5400 PRINT " "
5410 PRINT " "
5420 LET SP=0
5430 LET IP=0

```

```

5430 PAUSE YM
5440 FAST
5450 GOSUB VAL "5E2"
5460 CLS
5470 IF Q$="Y" THEN GOTO VAL "55
50"
5475 SLOW
5480 PRINT " INPUT STARTING X CO
ORD. "
5490 INPUT X
5495 PRINT X
5500 PRINT " "
5510 INPUT Y
5515 PRINT Y
5520 PRINT " "
5530 PRINT " "
5540 PRINT " "
5550 PRINT " "
5560 PRINT " "
5570 PRINT " "
5580 PRINT " "
5590 PRINT " "
5600 PRINT " "
5610 PRINT " "
5620 PRINT " "
5630 PRINT " "
5640 PRINT " "
5650 PRINT " "
5660 PRINT " "
5670 PRINT " "
5680 PRINT " "
5690 PRINT " "
5700 PRINT " "
5710 PRINT " "
5720 PRINT " "
5730 PRINT " "
5740 PRINT " "
5750 PRINT " "
5760 PRINT " "
5770 PRINT " "
5780 PRINT " "
5790 PRINT " "
5800 PRINT " "
5810 PRINT " "
5820 PRINT " "
5830 PRINT " "
5840 PRINT " "
5850 PRINT " "
5860 PRINT " "
5870 PRINT " "
5880 PRINT " "
5890 PRINT " "
5900 PRINT " "
5910 PRINT " "
5920 PRINT " "
5930 PRINT " "
5940 PRINT " "
5950 PRINT " "
5960 PRINT " "
5970 PRINT " "
5980 PRINT " "
5990 PRINT " "
6000 PRINT " "

```

```

5860 IF F THEN PRINT " "
5870 IF F THEN PRINT " "
5880 IF F THEN PRINT " "
5890 IF F THEN PRINT " "
5900 IF F THEN PRINT " "
5910 IF F THEN PRINT " "
5920 IF F THEN PRINT " "
5930 IF F THEN PRINT " "
5940 IF F THEN PRINT " "
5950 IF F THEN PRINT " "
5960 IF F THEN PRINT " "
5970 IF F THEN PRINT " "
5980 IF F THEN PRINT " "
5990 IF F THEN PRINT " "
6000 IF F THEN PRINT " "
6010 IF F THEN PRINT " "
6020 IF F THEN PRINT " "
6030 IF F THEN PRINT " "
6040 IF F THEN PRINT " "
6050 IF F THEN PRINT " "
6060 IF F THEN PRINT " "
6070 IF F THEN PRINT " "
6080 IF F THEN PRINT " "
6090 IF F THEN PRINT " "
6100 IF F THEN PRINT " "
6110 IF F THEN PRINT " "
6120 IF F THEN PRINT " "
6130 IF F THEN PRINT " "
6140 IF F THEN PRINT " "
6150 IF F THEN PRINT " "
6160 IF F THEN PRINT " "
6170 IF F THEN PRINT " "
6180 IF F THEN PRINT " "
6190 IF F THEN PRINT " "
6200 IF F THEN PRINT " "
6210 IF F THEN PRINT " "
6220 IF F THEN PRINT " "
6230 IF F THEN PRINT " "
6240 IF F THEN PRINT " "
6250 IF F THEN PRINT " "
6260 IF F THEN PRINT " "
6270 IF F THEN PRINT " "
6280 IF F THEN PRINT " "
6290 IF F THEN PRINT " "
6300 IF F THEN PRINT " "
6310 IF F THEN PRINT " "
6320 IF F THEN PRINT " "
6330 IF F THEN PRINT " "
6340 IF F THEN PRINT " "
6350 IF F THEN PRINT " "
6360 IF F THEN PRINT " "
6370 IF F THEN PRINT " "
6380 IF F THEN PRINT " "
6390 IF F THEN PRINT " "
6400 IF F THEN PRINT " "
6410 IF F THEN PRINT " "
6420 IF F THEN PRINT " "
6430 IF F THEN PRINT " "
6440 IF F THEN PRINT " "
6450 IF F THEN PRINT " "
6460 IF F THEN PRINT " "
6470 IF F THEN PRINT " "
6480 IF F THEN PRINT " "
6490 IF F THEN PRINT " "
6500 IF F THEN PRINT " "
6510 IF F THEN PRINT " "
6520 IF F THEN PRINT " "
6530 IF F THEN PRINT " "
6540 IF F THEN PRINT " "
6550 IF F THEN PRINT " "
6560 IF F THEN PRINT " "
6570 IF F THEN PRINT " "
6580 IF F THEN PRINT " "
6590 IF F THEN PRINT " "
6600 IF F THEN PRINT " "
6610 IF F THEN PRINT " "
6620 IF F THEN PRINT " "
6630 IF F THEN PRINT " "
6640 IF F THEN PRINT " "
6650 IF F THEN PRINT " "
6660 IF F THEN PRINT " "
6670 IF F THEN PRINT " "
6680 IF F THEN PRINT " "
6690 IF F THEN PRINT " "
6700 IF F THEN PRINT " "
6710 IF F THEN PRINT " "
6720 IF F THEN PRINT " "
6730 IF F THEN PRINT " "
6740 IF F THEN PRINT " "
6750 IF F THEN PRINT " "
6760 IF F THEN PRINT " "
6770 IF F THEN PRINT " "
6780 IF F THEN PRINT " "
6790 IF F THEN PRINT " "
6800 IF F THEN PRINT " "
6810 IF F THEN PRINT " "
6820 IF F THEN PRINT " "
6830 IF F THEN PRINT " "
6840 IF F THEN PRINT " "
6850 IF F THEN PRINT " "
6860 IF F THEN PRINT " "
6870 IF F THEN PRINT " "
6880 IF F THEN PRINT " "
6890 IF F THEN PRINT " "
6900 IF F THEN PRINT " "
6910 IF F THEN PRINT " "
6920 IF F THEN PRINT " "
6930 IF F THEN PRINT " "
6940 IF F THEN PRINT " "
6950 IF F THEN PRINT " "
6960 IF F THEN PRINT " "
6970 IF F THEN PRINT " "
6980 IF F THEN PRINT " "
6990 IF F THEN PRINT " "
7000 IF F THEN PRINT " "

```

AFR SOFTWARE®

Presents:
Powerful And Inexpensive
Business Software
For "Timex-Sinclair"
Computers

WORD PROCESSING

T/S-TEXT 2000\$19.95
ZX-TEXT\$19.95

SPREADSHEET CALCULATOR

T/S-CALC 2000\$19.95
ZX-CALC\$19.95

CYCLE ACCOUNTING

T/S-ZX Financial Report Generator\$29.95
Printout Of Same\$13.00

APPOINTMENT SCHEDULER

T/S-CALENDAR 2000\$19.95
ZX-CALENDAR\$19.95

Send S.A.S.E. For Free Catalog
Or Check Or Money Order To:
A.F.R. SOFTWARE
1605 Pennsylvania Ave.
No. 204
Miami Beach, FL 33139
(305) 531-6464
FLORIDIANS ADD SALES TAX
Dealer Inquires Invited



GIFT TIME ALREADY?

IT SURE IS!

How about giving your favorite
TS-er a great holiday gift:
A LARKEN 2068 DISK SYSTEM
As our way of saying thank you for
your continued support, RMG will
sell you a COMPLETE disk system
for only:



\$175.00!



(Plus \$12 P&H)

System includes 2-3" SSDD drives
case/power supply/cable
AND the LARKEN LKDS I/F with s/w.
WHERE HAVE YOU SEEN SUCH A DEAL?
System is also compatible with the
new LARKEN RAMDISK. Don't wait!
OFFER ENDS 1/15/88 - POSITIVELY!

RMG ENTERPRISES
1419 1/2 7TH STREET
OREGON CITY, OREGON 97045
503/655-7484 * NOON-10 TUE-SAT

CREATING A FOUR-PORT EXPANSION DECODER

by Ed Fry

I was impressed with Ed's Expansion Decoder project when he demonstrated it at the Northwest TS Mini-Fair this past summer. It was attached to, and controlled a variety of external gadgets, including a motor driven shaft, and an array of LEDs. With the low cost (going price is about \$10) and plentiful supply of surplus TS1000 and ZX81s, this expansion device just might make an ideal construction project for the winter months. The article appearing in this issue covers all of the necessary schematics, instructions, and theory to put it together; in another article (or articles), Ed will discuss how to use and put it to work for you. A variety of suggestions have been made: remote controller for a satellite dish, burglar alarm system, weather station, and model railroad applications. In the article Ed offers a parts kit, and be sure to write, if you have any comments or questions.

- Editor

As most faithful Sinclair owners know, our gracious Sir Clive did not allow the user access to a fine feature of the Z80 CPU known as IROQ (input/output request).

You could, of course, tie into the keyboard inputs and use an amplified signal to trigger an SCR out of the earphone jack, but that would only allow one bit; it would also use up valuable memory.

The most efficient way to do it on our computer would be to "POKE and PEEK" and "memory map" the I/O out of the range of present ROM or RAM. This is where the Expansion Decoder comes into play.

We all know that Sinclair cut a lot of corners wherever possible. The Z80 CPU is capable of directly accessing 65,536 (64K) bits of memory. Due to the incomplete memory decoding in the bare ZX81, about 55K of that memory is "images" of the 8K ROM and 1K or 2K RAM. This means that the 8K ROM plus it's images occupy 32K of memory, and the RAM occupies the other 32K. Why??

(NOTE: From this point on, any time you see a number preceded by a "\$", it represents that the number is a HEXADECIMAL number). Now, to repeat myself, the Z80 CPU is capable of addressing one of any 65,536 addresses or bits (\$0000 thru \$FFFF) by placing the bits on the 16 (0-15) address lines "hi" or "low". Decoding is the process of generating a "strobe" whenever a particular address combination appears on the "Address Bus".

When decoding for memory, a large number of address combinations must be decoded to provide a strobe that activates the memory chip whenever any address in that range is on the bus. Each memory chip has its own internal decoding to select the exact byte in the range of the address to read. This latter stage of decoding in an 8K ROM for example, determines which of the 8,192 bytes in the ROM is to be sent to the Z80. In order to make this selection, the lower 13 address lines must be wired directly to the ROM, and the address strobe, decoded from the remaining three address lines, is wired to the ROM's chip select pin. The chip select requires a low in order to become active.

In a fully decoded system, all three upper address lines (A13, A14 and A15) would go through a decoder, that would provide a low-going strobe to select the ROM when its address range (for example, \$0000 to \$1FFF) is selected. In the ZX81 and TS1000, the 8K ROM is activated anytime the address line A14 is at a low level, and the 1K/2K RAM is active anytime (thru an inverter chip) A14 is high.

What does this do to address space?? Let's look at our three upper address lines (knowing that the first 13 are directly wired to the ROM). Let's let an

"X" = a "I don't care"
 "1" = a "high"
 "0" = a "low"

| The ROM is active when- Or when these combinations appear- | A15=X | A14=0 | A13=X |
|--|-------|-------|-------|
| 0 | 0 | 0 | 0 |
| 0 | 0 | 0 | 1 |
| 1 | 0 | 0 | 0 |
| 1 | 0 | 1 | 1 |

As you can see, this will activate the 8K ROM a total of 4 different address locations, or the original plus three images for a total use of 32K of memory space! The same thing happens with our 1K or 2K RAM, except we have either 31 or 15 images respectively. Anyway we look at it, there goes our 64K of memory.

If you would like to prove the existence of those "images", here is a little program you can run. What we will do is look or PEEK at the first byte of ROM and then compare it to the first byte in all the remaining ascending 1K blocks to the end of the 64K. Wherever it matches, it will print that address location on the screen.

```

10 LET AS=0
20 LET B=PEEK(AS)
30 FAST
40 FOR N=0 TO 65535 STEP 1024
50 IF PEEK N=B THEN PRINT N,
60 NEXT N
70 SLOW
    
```

Since rom address starts a 0
 Assign byte to B to compar
 You can leave it slow
 To 64K in 1K steps
 Making comparison
 You know what this does
 If you want

The following diagram is a representation of the Sinclair Memory Map before and after our Expansion Decoder has been added.

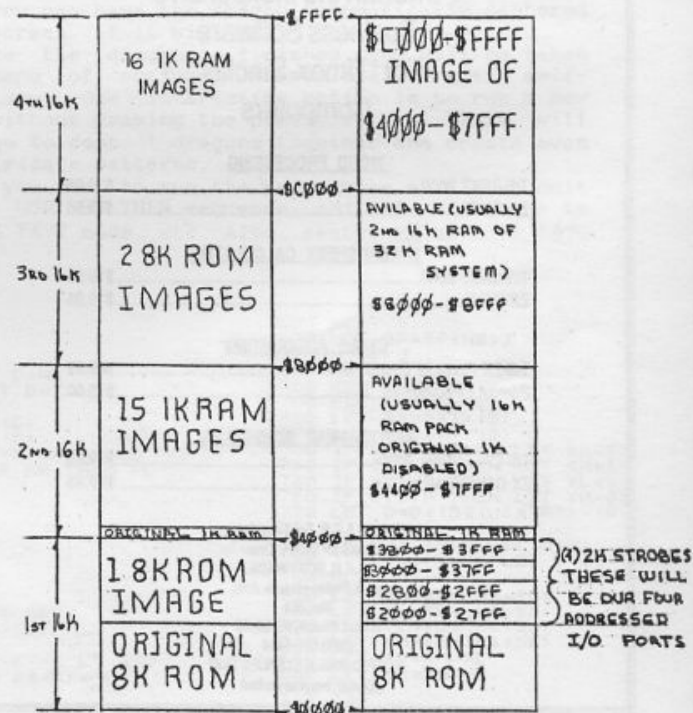

CONSTRUCTION TIPS

REMEMBER YOU ARE WORKING ON THE BOARD UPSIDE DOWN, SO ALL NUMBERS, PINOUTS, LAYOUTS, ETC., ARE A MIRROR IMAGE!!

- (1) Use a fine steel wool to clean any tarnish off the foil side of the P-board.
- (2) Locate and solder all components, connectors, and IC sockets to P-board.
- (3) Solder all +5 volt connections, then solder all ground connections.
- (4) Solder one chip at a time. Example: say you are starting with IC#1-pin #2. You also have a connection to the edge connector-#4a and IC#9-pin #3. Make all those connections then go back and finish the other connections on IC#1.
- (5) Pick up a wire-wrap tool at Radio Shack, or other electronics supplier. The Radio Shack tool has a little stripping tool inside the barrel of the wrap/unwrap tool. These tools run about \$5.50. Buy some hook-up wire to match the gage of the stripping tool.
- (6) When making a connection that goes to more than one point you might follow these instructions:
We will use the +5 volt run for an example. It has approximately 23 points to connect in the one run!
 - (a) First find all the points to be connected (remember the edge connector or if you build your own supply you will want a connector to the power supply and a connection to the +5 volts for the inputs).
 - (b) Find the shortest route. (you might use the layout sheet and lightly draw the path.)
 - (c) Cut a length of wire to follow the route laid out plus about 2 1/2 inches. (We will call this a trace.)
 - (d) Strip about 1 inch of insulation off one end.
 - (e) Heat the solder to the melting temperature at the point you have decided for the start. Immediately stick the end of the wire into the melted solder and remove the the solder iron. Let cool for a couple of seconds and let go of the wire. Give a little tug on wire to make sure of a good solid connection.
 - (f) Find the next point. Strip a length of insulation approximate to the distance between the two points if the distance between the two points is 1 inch then strip a length of insulation about 1 1/8 inches long.

- (g) Slide this 1 1/8 inch piece of insulation against the solder at the start point. DO NOT CUT THIS "TRACE" UNTIL ALL +5 VOLT POINTS ARE CONNECTED!!!!
- (h) Find your next point again. Place unsoldered end of 1 1/8 inch end of insulated wire at the next point (point "A"), as close as possible to the insulation. Repeat step (e).

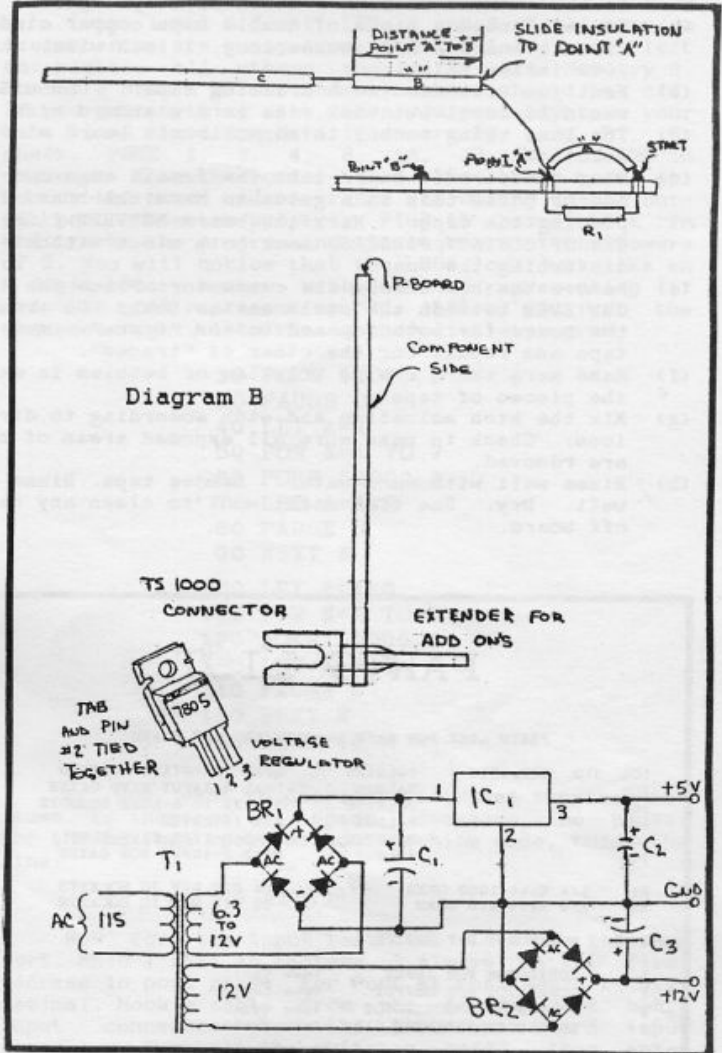

- (j) Repeat steps (h) thru (i) until "trace" is complete. After last point is soldered trim off any extra wire with a razor blade.
- (k) Go to next trace and continue till done.

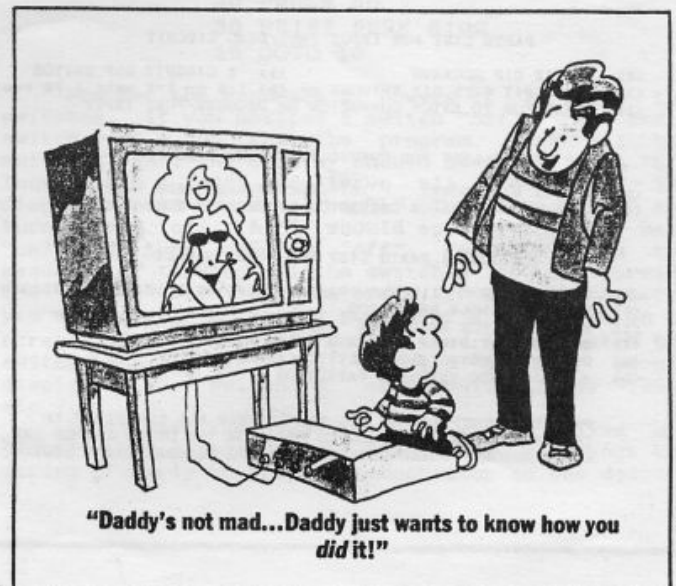
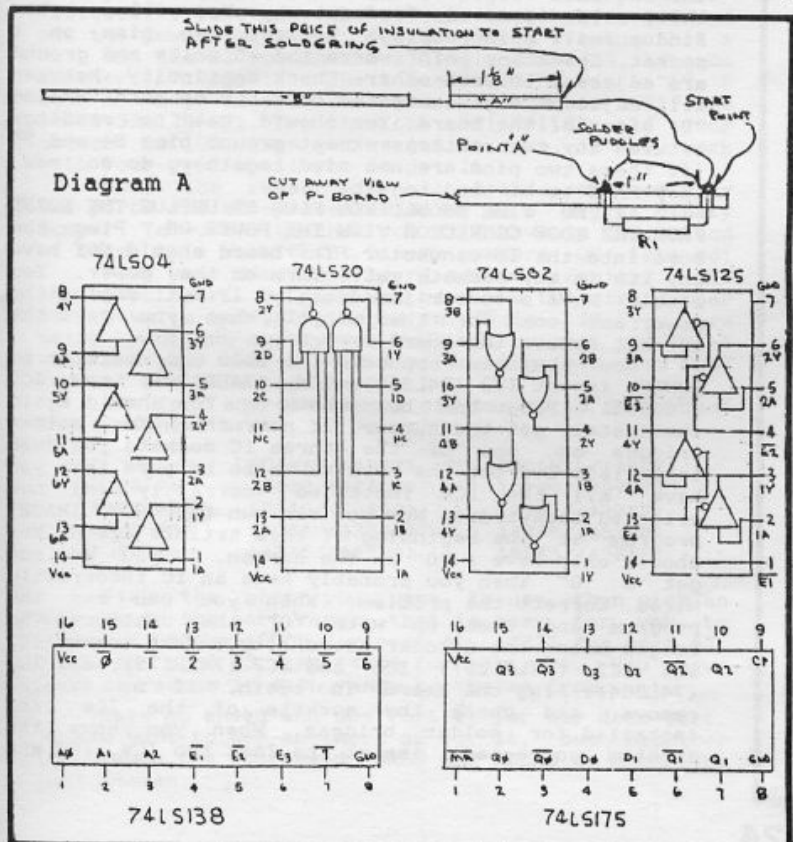

(7) For the TS1000 edge connector you will probably have to start with either a 50 or 100 pin connector and cut it to 46 pins. Be sure to buy one that has .100 inch spacing and also that the pins will go thru the holes in the P-board and have enough length to attach the extender card. (no less than 1/4 inch.)

(8) The extender!!! You probably will have to make one. Here is how. (Here we have a bunch of steps again.)

- (a) You will need a piece of double side copper clad circuit board 2 3/8 inches long, 1 inch wide, and .062 inches thick.
- (b) Next you will need some drafting tape. .050 wide would be ideal but .062 wide is a standard size.
- (c) The last thing to buy is some circuit board etch solution.
- (d) Plug the circuit board into the female edge connector. Use this as a guide to mark the board for placing the tape. Mark the board BETWEEN EACH SET OF CONTACT FINGERS, mark both sides without disturbing the board.
- (e) Remove the board from the connector. Place the tape CENTERED between the marks on the board. Go around the board for both top and bottom "trace". cut the tape and repeat for the other 44 "traces".
- (f) Make sure there are no wrinkles or bubbles in any of the pieces of tape.
- (g) Mix the etch solution and etch according to directions. Check to make sure all exposed areas of copper are removed.
- (h) Rinse well with warm water. Remove tape. Rinse again well. Dry. Use fine steel wool to clean any residue off board.

For the purchase of the connectors and IC sockets. I would recommend checking with any surplus stores or suppliers in MODERN ELECTRONICS or other electronic oriented magazines before Radio Shack (Radio Shack is the least expensive source of plated P-board I have found).

The I/O connectors can be of your choice, but I found the 8-pin sip header was the easiest to use. Whatever you use, be sure to get male/female pairs.

You can power the board from the TS supply, but if you want to add much in I/O you will have to be careful. The TS supply will only carry an additional 350ma or so (if you have the 1 amp power pack), much less if you have the old 650ma power pack. Strange things will happen if you overload the power supply. I have included a simple regulated +5 volt power supply and unregulated 12 volt supply. The 12 volts may be regulated with a +12 volt regulator and the same basic circuit as the +5 volt supply. (The 12 volts will be used on a later project for the output port.)

To test the power supply, plug in and check voltages. CAUTION: YOU ARE DEALING WITH 110 VOLTS. IT POTENTIALLY CAN KILL!!

The construction of the two test/demo circuits is the same as the main decoder I/O board. For additional reference I have also included circuit drawings of all the ICs used in the project.

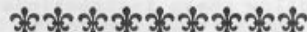

A complete set of "hacker parts" can be obtained from the author (some parts are new and some are used, but ALL are guaranteed good)...less the circuit board and connectors. This includes the test/demo boards, BUT not the optional power supply parts. The price for the parts kit is \$20 + \$1.50 S&H (while supplies last). I will also provide a transformer with dual 12 volt secondaries suitable for the optional power supply for an additional \$2.00 + \$1.50 S&H, if ordered with the main parts kit. Send check or money order to: ED FRY, 7044 N.E. 8th, Portland, OR 97211.

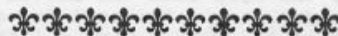

DO NOT connect the 1000 ohm resistor to ROMCS at this time. Using an ohmmeter or continuity checker, check for shorts between +5 volt contact (1B) and GND (4B and 5B). You should read an open circuit. If anything else is noted, find out why. You will probably find a small solder bridge between two pins on a socket. Check any point where the +5 volts and ground are adjacent to each other. Check continuity between all adjacent edge connector contacts on both "A" and "B" sides of the board. You should get no readings between any two contacts except ground pins B4 and B5 (if these two pins are not tied together, do so now, they HAVE to be tied together).

AT NO TIME SHOULD YOU PLUG OR UNPLUG THE BOARD FROM THE EDGE CONNECTOR WITH THE POWER ON. Plug the board into the TS connector. The board should NOT have any ICs in any sockets yet!! Turn on the power. You should have a cursor immediately. If not, unplug the power and look for the short. When you get the cursor, remove the board.

Now you can connect the 1000 ohm resistor to ROMCS, insert IC3 (74LS20), IC4 (74LS138), and IC5 (74LS04). Plug the board back in. You should again immediately get the cursor. If not, check for solder bridges on one of the three IC sockets you just installed. Correct the problem (also be sure that you have all the ICs installed correctly and not oriented backwards). Now you can run the "ROM IMAGE" program at the beginning of this article again. You should only have a "0" on the screen. If you do not get a "0" then you probably have an IC incorrectly wired. Correct the problem. When you can run the program and come up with "0" then continue. (No images means the decoder is working.) Next insert IC1 and IC2 (74LS125), IC6 and IC7 (74LS175), and IC8 (74LS04). Plug the board in again, if no cursor, remove and check the sockets of the ICs last installed for solder bridges. When you have the problem corrected, insert the last two ICs, IC9 and

PARTS LIST

PARTS LIST FOR MAIN DECODER AND I/O BOARD

| | | |
|---------------------|---------|--------------------------|
| IC1, IC2, IC9, IC10 | 74LS125 | QUAD TRI-STATE BUFFERS |
| IC3 | 74LS20 | DUAL 4-INPUT NAND GATES |
| IC4 | 74LS138 | 3-LINE TO 8-LINE DECODER |
| IC5 | 74LS04 | HEX INVERTER |
| IC6, IC7 | 74LS175 | QUAD D-TYPE FLIP-FLOP |
| IC8 | 74LS02 | QUAD 2-INPUT NOR GATES |

| | | | |
|----|--------------------|---|-----------------------|
| R1 | 1/4 Watt 1000 OHMS | 7 | 14 PIN DIP IC SOCKETS |
| R2 | 1/4 Watt 270 OHMS | 3 | 16 PIN DIP IC SOCKETS |

1 4 CIRCUIT DIP SWITCH

| | | |
|---|-------------------------|------------|
| 1 | CONNECTOR FOR INPUT | (see text) |
| 1 | CONNECTOR FOR OUTPUT | (see text) |
| 1 | 46 PIN EDGE CONNECTOR | (see text) |
| 1 | 46 FINGER EXTENDER CARD | (see text) |

1 PERF-BOARD (P-BOARD) RADIO SHACK #276-147 (cut in half)

MISCELLANEOUS

FINE STEEL WOOL ROSIN CORE SOLDER WIRE STRIPPER
WIRE 25 WATT OR LESS SOLDERING IRON (too high of a wattage will lift the solder pads off the P-board)

PARTS LIST FOR INPUT TEST/DEMO CIRCUIT

| | | | |
|-----|--|--------|--------------------------------|
| (2) | 16 PIN DIP SOCKETS | (1) | 8 CIRCUIT DIP SWITCH |
| (1) | 8 CIRCUIT 4.7K DIP NETWORK | or (8) | 1/8 or 1/4 watt 4.7K resistors |
| (1) | CONNECTOR TO MATCH CONNECTOR ON DECODER/PORT INPUT | | |

PARTS LIST FOR OUTPUT TEST/DEMO CIRCUIT

| | | | |
|-----|---|-----|-------------------------------|
| (1) | 16 PIN DIP SOCKET | (8) | RECTANGULAR LEADS (any color) |
| (1) | CONNECTOR TO MATCH CONNECTOR ON DECODER/PORT OUTPUT | | |

(OPTIONAL) PARTS LIST FOR POWER SUPPLY

| | | | |
|-----|-------------------------|-----------------------------|----------------------------|
| (1) | TRANSFORMER | 115 VAC PRIMARY | AND DUAL 12VAC SECONDARIES |
| (1) | 7805 | +5 VOLT REGULATOR | |
| (1) | HEAT SINK FOR REGULATOR | (optional but worth it) | |
| (2) | BRIDGE RECTIFIERS | MINIMUM OF 50 VOLTS @ 1 AMP | |
| (2) | 2200uf @ 25VDC | ELECTROLYTIC CAPACITORS | |
| (1) | 4.7uf @16VDC | TANTALUM CAPACITOR | |

WITH THE EXCEPTION OF THE TRANSFORMER ALL THE PARTS IN THE LAST THREE LISTS SHOULD MOUNT ON THE OTHER 1/2 OF THE RADIO SHACK P-BOARD MENTIONED IN THE DECODER PARTS LIST.

IC10 (74LS125). Go thru the check procedure again. When all the ICs are inserted and cursor comes on properly, the board is complete. Run the "ROM IMAGE" program one more time, make sure of the "0" readout and we will go to the I/O test/demo.

OUTPUT PORT TEST/DEMO

We are going to discuss just a little bit about binary numbers (if you need more info, you should be able to get a book at the library). First, the largest number in decimal that we can express with an 8-digit binary number is 255 (i.e., 11111111). The smallest is 0 (i.e., 00000000). Just as decimal deals in powers of 10 (i.e., 1, 10, 100, 1000, etc.), binary deals with powers of 2 (i.e., 1, 2, 4, 8, 16, etc.). Since we will only be dealing with 8 digits of binary, I will stop at the 8th power (128). A grid chart is provided to further the discussion.

| DECIMAL | 128 | 64 | 32 | 16 | 8 | 4 | 2 | 1 |
|---------|-----|----|----|----|---|---|---|---|
| 1 = | 0 | 0 | 0 | 0 | 0 | 0 | 0 | 1 |
| 135 = | 1 | 0 | 0 | 0 | 0 | 1 | 1 | 1 |
| 15 = | 0 | 0 | 0 | 0 | 1 | 1 | 1 | 1 |
| 254 = | 1 | 1 | 1 | 1 | 1 | 1 | 1 | 0 |
| 124 = | | | | | | | | |

To convert a decimal to a binary number, select the decimal number, in this case 124. Start with the eighth of the powers of 2 columns (i.e., 128). 128 will not subtract from 124 (we are only using positive numbers), so we place a "0" in the 128 column. 64 will subtract from 124, so we will place a "1" in the 64 column. $124-64=60$ right. We will always work with the remainder. 32 will subtract from 60 so put a "1" in the 32 column. $60-32=28$. 16 will subtract from 28, a "1" goes in the 16 column. $28-16=12$. 8 will subtract from 12, a "1" in the 8 column. $12-8=4$. 4 will subtract from 4, a "1" in the 4 column. $4-4=0$, that means all the rest get a "0". Our 8 digit binary number for decimal 124 will look like this: "01111100". Lets try another like 174. Work it out by yourself. The answer should be "10101110" binary. Easy...right?!

Now lets go the other way; that is, to convert binary to decimal. Take an 8 digit binary number "00100001". Take only the columns that have a "1" and add the powers of 2 up. "00100001" the 1 column has a "1" and the 32 column has a "1", so $32+1=33$. Lets do another... "10101011". The 1 has a "1", 2 has a "1", 8 has a "1", 32 has a "1", and 128 has a "1", so $1+2+8+32+128=171$. Try this one: "01100110". If your answer is 102, then you've got it down, if not, work with your grid until you do get it.

Now, the reason for all of this, is that your I/O ports are a representation of an 8 digit binary number. To work with them you will have to understand at least this much about binary numbers. OK..lets go!

Plug your demo/test board output circuitry into the output port. Be sure you have the two wire jumper for +5 volts and GND plugged in. (Note: If you are using your own supply you MUST NOT connect the TS +5 volt and your own +5 volt supplies together. You MUST connect the GNDs together).

The four address ranges of your ports in decimal and in (\$hex) are:

| PORT # | DECIMAL/(\$HEX) | TO | DECIMAL/(\$HEX) |
|---------|-----------------|----|-----------------|
| PORT #1 | 8192/(\$2000) | | 10239/(\$27FF) |
| PORT #2 | 10240/(\$2800) | | 12287/(\$2FFF) |
| PORT #3 | 12288/(\$3000) | | 14335/(\$37FF) |
| PORT #4 | 14336/(\$3800) | | 16383/(\$3FFF) |

Pick the port you want to use, then pick an address in the port range, that is easy for you to remember. I use 10000 for port #1, 12222 for port #2, 13333 for port #3, and 14444 for port #4. You have 2047 addresses in each range to choose from.

Lets go ahead and use Port #1 for our demo port. If you want to use another, go for it, but remember to change the addressed POKES and PEEKS to match the port chosen.

If you have everything hooked up, turn the power on. You might have one or more random LEDs on, but that's ok. First enter POKE 10000,0. That should turn all the LEDs off. Next enter POKE 10000,255 that should turn all the LEDs on. Next lets make a little program:

```
10 INPUT X
20 POKE 10000,X
30 GOTO 10
```

Lets input 3 first. LEDs 1 and 2 should turn on (remember we are going from right to left, not left to right), all others should be off. Now try 8. Number 4 should be on, and all others should be off. If you get anything else, then you probably have your data lines mixed up. Data lines are D0 thru D7. To check, POKE 1, 2, 4, 8, 16, 32, 64, and 128 in sequence. Note the order that the LEDs turn on. Remove the board and rearrange the wiring to the output port connector properly. Plug th board back in and rerun the program and the sequence of the powers of 2. You will notice that the LEDs look just like an 8 digit binary number, with "LED on" representing "1" and "LED off" representing "0". After you get the sequence right, lets run another little program:

```
10 POKE 10000,0
20 PAUSE 30
40 LET A=1
50 FOR N=1 TO 7
60 POKE 10000,A
70 LET A=A*2
80 PAUSE 5
90 NEXT N
100 LET A=128
110 FOR N=1 TO 7
120 POKE 10000,A
130 LET A=A/2
140 PAUSE 5
150 NEXT N
160 GOTO 40
```

If you want to decrease the speed increase the pause. To increase the speed, decrease the pause. For the maximum speed without machine code, add the line:

```
5 FAST
```

Now for the input test/demo. Lets use the same port. When I PEEK an address, I always use the first address in port range. For Port #1 that would be 8192 decimal. Hook a cable from the decoder/port board input connector to the test/demo board input connector. Turn all the switches "off", then enter PRINT PEEK 8192. The display should read "255". Now turn all the switches "on". The display should read "0". If you do not get these results, then run this program:

```
10 SCROLL
20 PAUSE 30
30 PRINT PEEK 8192
40 GOTO 10
```

Now set the sequence of powers of 2 using the switches. If you noticed a switch "off" = "1", and a switch "on" = "0", run the program. Turn all the switches "on". The display should be scrolling a "0". Turn switch 1 "off" and leave all others on. The display should now scroll a "1". Turn 1 back "on" and turn only 2 "off". A "2" should appear. Turn 2 back "on" and turn only 3 "off". Continue thru the sequence of turning all the switches "on" and turning one switch back "off" in order, from right to left. you should get increasing powers of 2 displayed on the screen. The power of 2 displayed should match the switch that is "off" (i.e., switch 5 "off" should display "16", switch 8 "off" would display "128", etc.).

Again note the sequence. If it is mixed up, unplug the decoder port board and rearrange the wiring properly to the input connector on the decoder

board. Once you get everything squared away, here is our last little demo program. Plug both the input and output connectors into the decoder port board. Just for kicks, we will change our port select switch to Port #2. Here is the program:

```

10 POKE 12222,0
20 PAUSE 30
30 LET A=PEEK 10240
40 POKE 12222,A
50 GOTO 30
  
```

Now you will note that for any switch that is "off" on the input port, there will be the corresponding LED "on" for the output port.

These programs and demo, should give you something to play with until the next issue of TIME DESIGNS, when we will explore different types of output driver cards and applications. Have Fun!

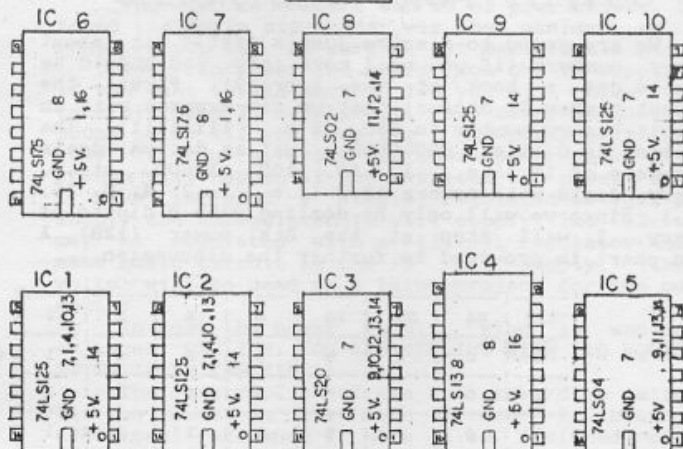
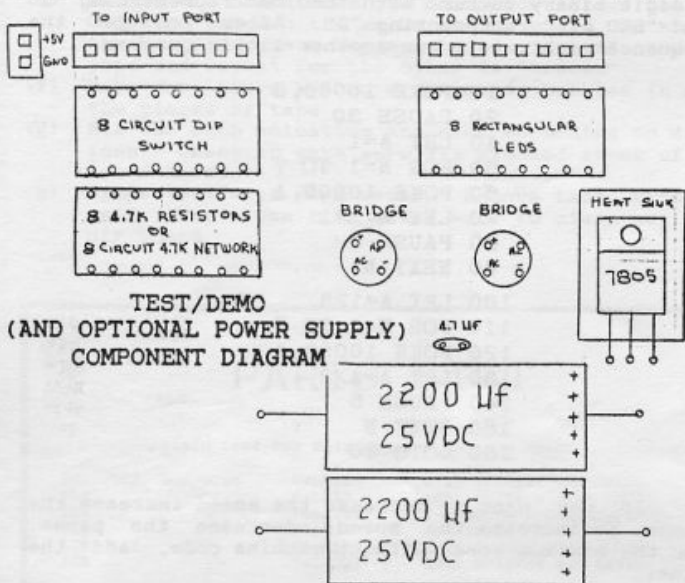

BE SURE TO TIE GROUND PINS B4 & B5 TOGETHER

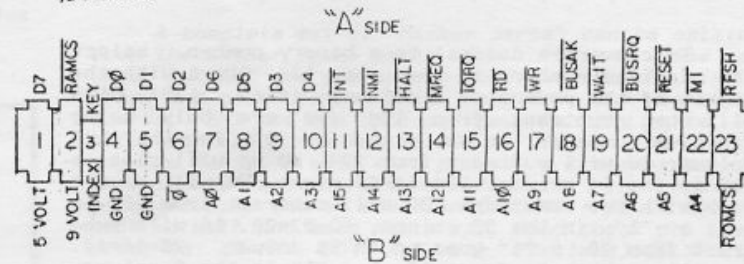

MAIN DECODER COMPONENT DIAGRAM

MAIN DECODER AND I/O BOARD CIRCUIT

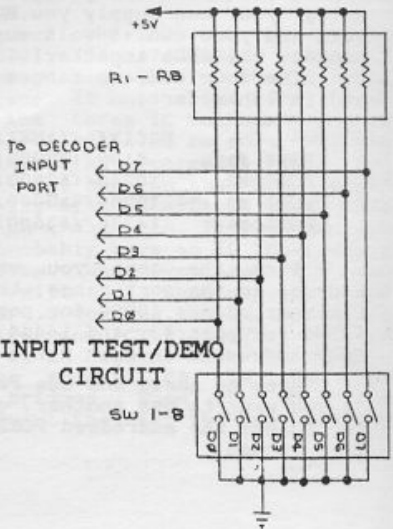
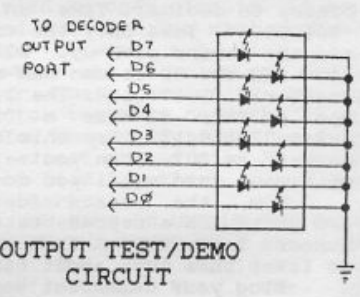
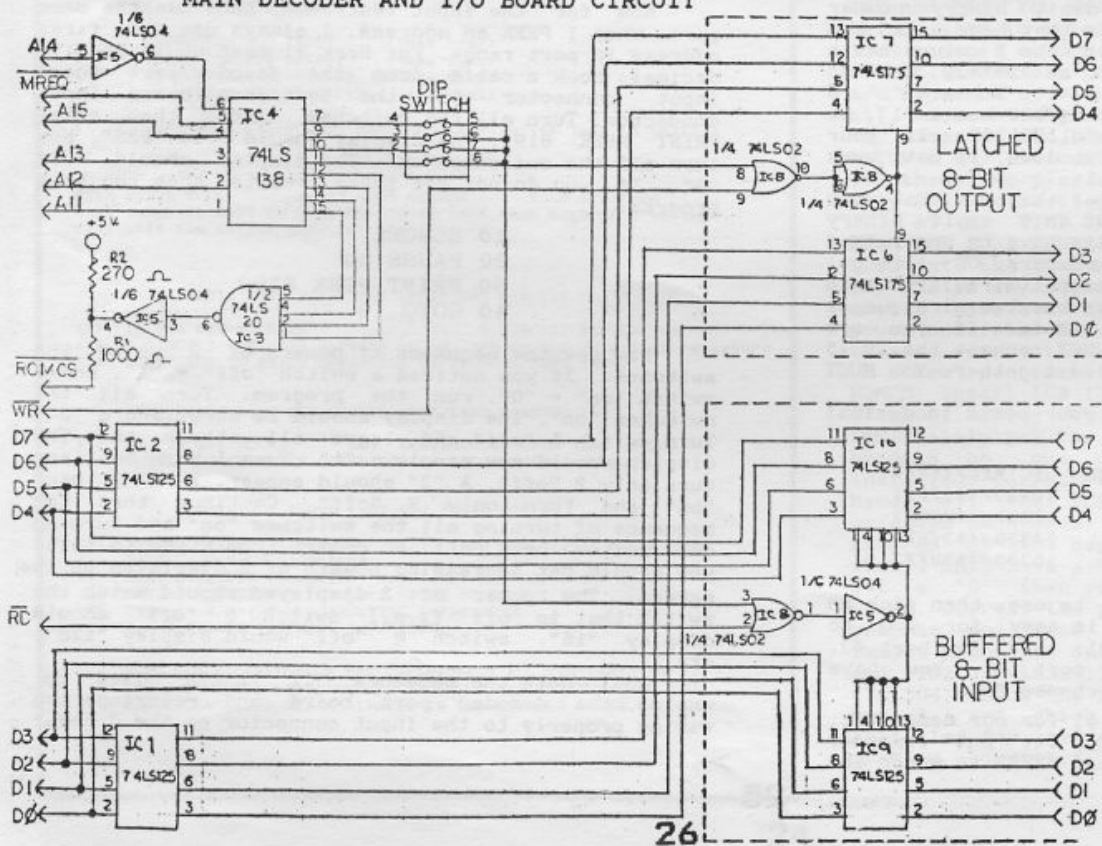

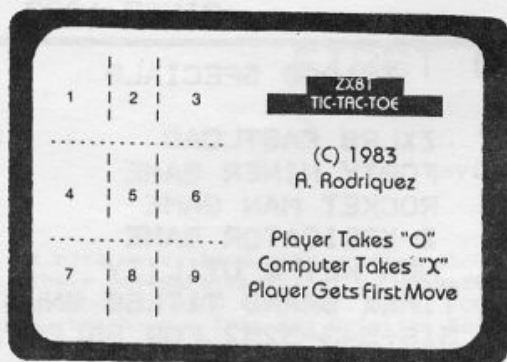

ZX81 TIC-TAC-TOE

Copyright (c) 1983
Albert F. Rodriguez

PROFILE

Price: \$12.00 in cassette (domestic)
\$14.00 (foreign)
With documentation

For: ZX81, TS1000, TS1500 ROM/RAM: 8K/16K

Written In: Sinclair BASIC Program Listable: No

Listings Available:

Yes, \$6.20 (domestic)/\$7.20 (foreign) with documentation

Syntactic Sum: 433, 255

This program was written to be both entertaining and educational to its user.

There are about 457 variations of this game that can be played, given how the program is written.

The computer plays an optimal game. It goes for a win when it can or it attempts to prevent from losing by yielding a draw. The challenge for the player is, of course, in trying to beat the computer or in not letting it beat him/her by forcing a draw.

The player is always allowed the first move; thereby, giving him/her five moves versus the four moves allowed the computer. The player and computer are pre-assigned the characters "O" and "X"; respectively, in inverse video.

The program is self-running. Within the program are instructions for exiting and re-entering the game (e.g., to exit press BREAK during execution; to enter key in GOTO 7). Never should the player enter either RUN or CLEAR; for this will erase all data pre-programmed into the variable store. If this should occur, reloading the program from cassette is necessary.

There are three distinct features of this program that make it very "user-friendly".

First, if the player makes a move with any type of data other than the single numbers 1 through 9, he/she will receive a prompt message that says: FALSE MOVE; TRY AGAIN.

Second, if during the course of a particular game a player makes a move already taken by either himself/herself or the computer, then, a prompt message will appear that says: REPEAT; TRY AGAIN.

Both of the above prompts appear for about two seconds, self-erase and then allow for a new move to be entered.

Third, in the event that the game ends either in a WIN or a DRAW, a prompt message is displayed informing the player of either outcome. In the case of a WIN an extra nicety is added: a thick, black line crossing through the row, column or diagonal in which three characters of the same kind appear.

When a game comes to an end the final outcome is displayed for about fifteen seconds, then the program loops back to the beginning and sets itself up for a new game.

Listings of the program are available for a said price, but without the necessary data pre-incorporated into the variable store it is non-functional. There is certain information that was put into the program via the immediate, input mode which is essential for the proper execution of this program.

A complete listing of the program, its arrays/variables and their respective values are for sale and may be bought for a very reasonable price. Along with this information the buyer will receive detailed documentation about how this program was made as a precise and interesting computer game that is fun to play and, hopefully, a worthwhile tutorial in computer programming.

If bought in cassette the above documentation comes with it, but the program is not listable on the screen. This was done to prevent any "bugs" from sneaking into the program inadvertently that might cause the program not to execute properly. Thereby, this should allow the buyer to have full satisfaction about what he/she is buying for his/her money.

A.F.A. SOFTWARE

1605 Pennsylvania Ave./No. 204

Miami Beach, FL 33139 U.S.A.

(305) 531-6464

Floridians add Sales Tax

Dealer Inquiries Welcome

L-3 (c) 7/86

1-800-962-1988
EXT. 122
24 HOUR ORDER LINE.

TIMEX/SINCLAIR SPECIALS

WMJ DATA SYSTEMS
SUPPORTING T/S
SINCE 1983

ALPHACOM 32 PRINTER
(#ALPHA) \$35.00
ORIGINALLY SOLD FOR \$89.95. THIS
PRINTER IS 100% COMPATIBLE WITH THE
ZX81, TS1000, TS1500 AND TS2068.
ONE ROLL OF THERMAL PAPER SUPPLIED.
EXTRA PAPER 3 ROLLS/\$6.00 (#THERM)

PRO/FILE 2068
TS2068 (#TS2PF) \$19.95
THIS PROGRAM WRITTEN BY THOMAS WOODS
IS ONE OF THE MOST USEFUL PROGRAMS
YOU WILL EVER OWN. PRO/FILE 2068
LETS YOU MAINTAIN INFORMATION IN ANY
FORM YOU DESIRE. YOU CAN DO MULTI-
WORD SEARCHES AND HAVE THE FILES
ON THE SCREEN OR PRINTED OUT IN A
MATTER OF SECONDS. THE BEST PART OF
THE PRO/FILE 2068 IS PROBABLY THE
144 PAGE MANUAL WHICH EXPLAINS THE
MANY USES OF PRO/FILE 2068 AS WELL
AS THE PROGRAMMING BEHIND IT. WORKS
ON THE TS2068 AND CAN BE USED WITH
ANY PRINTER.

ZX PRO/FILE
TS1000 (#TS1PF) \$16.95
A MACHINE LANGUAGE INFORMATION
STORAGE AND RETRIEVAL TOOL FOR 16K
TO 64K. WRITTEN BY THOMAS WOODS.
MULTI-WORD SEARCH CAPABILITY,
INSTANT FILE ACCESS, ORDERED
DISPLAYS, DEFINABLE PRINTOUTS, FLEX.
FILE SIZE, 59 PAGE TUTORIAL MANUAL.
THIS IS THE FINEST DATA BASE PROGRAM
WRITTEN FOR THE TS1000, TS1500, AND
SINCLAIR ZX81.

ACZ GENERAL LEDGER
TS1000 (#ACZ1) \$16.95
TS2068 (#ACZ2) \$19.95
AN ACCOUNTING SYSTEM DESIGNED FOR
THE SMALL BUSINESS. THE ACZ GENERAL
LEDGER IS FLEXIBLY DESIGNED SO THE
REPORTS FIT YOUR BUSINESS. INCLUDES
A COMPREHENSIVE MANUAL THAT WILL
HAVE YOUR BOOKS COMPUTERIZED IN A
SHORT TIME. THE ACZ GENERAL LEDGER
IS DESIGNED FOR USE WITH THE TS2040
OR ALPHACOM 32 PRINTER.

CALL OR WRITE FOR FREE CATALOG
1-800-962-1988 EXT. 122

TS1000 SPECIALS

| ITEM # | | |
|-----------------------------------|-------------------|---------|
| TS1FAST | ZXLR8 FASTLOAD | \$10.95 |
| TS1FOR | FORTY NINER GAME | 6.00 |
| TS1ROC | ROCKET MAN GAME | 6.00 |
| TS1ZXT | Z-XTRICATOR GAME | 6.00 |
| TS1KEY | NEW KEY & UTILITY | 6.00 |
| VARIOUS TIMEX BRAND TITLES ONLY | | 3.00 |
| (CALL 516-543-5252 FOR SELECTION) | | |

TS2068 SPECIALS

| ITEM # | | |
|--------|------------------------|---------|
| TX200 | CRAZY BUG | \$ 3.00 |
| TX202 | HOME IMPROVEMENT PLNR | 3.00 |
| TX208 | CASINO I | 3.00 |
| TX210 | SPELLING II | 3.00 |
| TX203 | CIRCUIT SCRAMBLER GAME | 3.00 |
| TX201 | SPELLING I | 3.00 |
| TX205 | STATES & CAPITALS | 3.00 |
| TX209 | BUDGETER | 3.00 |
| TX211 | WORD PLAY II | 3.00 |
| TS2DEN | DEALER'S POKER DEN | 12.95 |
| TS2FP | FIGHTER PILOT | 12.95 |
| TS2NG | NIGHT GUNNER | 9.95 |
| TS2TOM | TOMAHAWK | 12.95 |

BOOKS AND ACCESSORIES

| ITEM # | | |
|--------|----------------------|---------|
| TSPOW | POWERFUL PROJECTS | \$ 4.00 |
| TS2BIG | TS2068 BEG/INT GUIDE | 4.00 |
| TS2IAG | TS2068 INT/ADV GUIDE | 4.00 |
| 1420 | EPYX 500XJ JOYSTICK | 15.40 |

WINKY BOARD 2000
(#TSWINKY) \$19.95
SOLVES MOST LOADING PROBLEMS, ENABLES
YOU TO LOAD DIFFICULT TAPES WITH EASE
DUPLICATES TS/ZX CASSETTE TAPES FOR
BACK-UP COPY. SAVE/DUPLICATE AT THE
SAME TIME USING 2 RECORDERS. WORKS
WITH TS1000/1500, ZX81, SPECTRUM, TS2068

1-800-962-1988 EXT. 122 ORDERS ONLY.
PLEASE USE ITEM # WHEN ORDERING.
MASTERCARD * VISA * COD ORDERS
ADD \$3.00 SHIPPING IN U.S.
ADD \$8.00 SHIPPING IN CANADA, MEXICO
NO DELAY ON CHECKS.
CALL 516-543-5252 1PM-5PM MON-FRI FOR
ORDERS AND QUESTIONS.

MAIL ORDERS TO:
WMJ DATA SYSTEMS-TD
4 BUTTERFLY DRIVE
HAUPPAUGE, NY 11788

TS2068 SOFTWARE REVIEW

FIRST CLASS FONTS II

Reviewed by D. Hutchinson

A lot of nice words have been written about BYTE POWER and their software (magazine) on cassette tape for the Timex Sinclair 2068 computer. BYTE POWER is actually two brothers, Eric and Kristian Boisvert, who reside near Toronto, Ontario. If the Timex computer were still produced today, these gents would be very rich. Now, at best, every faithful 2068 user who has stuck it out should be buying their software. It's that good.

When the BYTE POWER duo started out a few years ago, they announced that their cassette magazine would be "published" on a monthly basis. Considering that each tape contained at least ten good programs, this monthly goal seemed to be a monumental task. I remember at the time thinking, "how are they going to do this?". There just isn't enough hours in a day to throw that much code! Well, they did manage to keep it up for a while, then deadlines began to slip.

Currently, BYTE POWER has gone to a quarterly format. I applaud this move for a couple of reasons. First of all, it will take the unrealistic deadline pressure off. A direct result of this has been noticeable improvements in the programs. Each "issue" gets better and better. And another result has allowed the programming team to develop larger full blown individual software packages outside of the regular cassette magazine. 1st CLASS FONTS II is one of these new programs.

When Tim (Editor of TDM) sent me a copy of 1st CLASS FONTS II in the mail for review, I knew right away that I was in for a treat. The software comes packaged in a vinyl album. There are two cassette tapes and a professionally printed user guide, which is quite clear and "to the point"...a rare commodity in the TS market. Actually (and the manual encourages it), documentation isn't really needed to get started with this program. Ideally, a program should stand alone without ever having to crack a manual. This is my "acid test" for any program that claims to be "user friendly". FONTS has come very close to achieving this, thanks to an operating system that is frequently seen in other BYTE POWER programs...sort of a "trademark" (more on this in a minute).

1st CLASS FONTS II's main program has three basic parts: 1. A library of "fonts" (or type styles). 28 different fonts are included in the main program. 2. A simple word processor ("what-you-see-is-what-you-get" type). 3. A "Definer", that allows the user to modify or change any character within one of the font sets.

To move around the program, a joystick is highly recommended by this reviewer, although using the keyboard is acceptable. If you haven't used one of the BYTE POWER programs that have similar "pop-down" menus as the FONTS package does, you may miss out on witnessing how powerful your 2068 can be. It works just like a mouse does on (gulp) the more expensive MACINTOSH computer. A little arrow icon is moved around the screen, and when the arrow is placed over a box or any command line, that box or line is highlighted by another color, and when the fire button is pressed, it automatically executes the function, or another menu box is superimposed over the previous menu. It's fast and smooth. Folk's this is as close as your 2068 will get to a MAC!

How do you use FONTS? Two ways actually. One quick way is via the built-in wordprocessor which allows the user to switch styles and experiment with several within the text workspace, and then print out with the TS-2040 printer. The other way, is to use a font character set within one of your own programs. This is the one time the user manual will need to be consulted, as it shows how to POKE the new character set's address in memory.

On the other cassette that is supplied, there is a 64 column print utility, a double-height print utility, a giant "Old English" font, and a scrolling font demonstration program.

There are some features that I feel should have been included in FONTS. First of all, the program is "unlistable", and for the average 2068 user, it is unbreakable". This is unfortunate, as I was unable to modify the LOAD and SAVE routines for my disk drive system. I also felt that a full-size printer driver should have been included in the wordprocessor for the AERCO printer interface. Many 2068 users no longer make use of the 2040 thermal printer. My final suggestion is only a minor one. It would have been nice to LOAD another whole library of 28 fonts into the main program. Only single font sets can be loaded in one at a time, replacing current ones.

Setting aside minor quibblings, I liked this software package. It represents fine value, with all of the extra trimmings that are included. Why not add it to your 2068 collection? It just might be what your looking for to "dress up" your text and programs.

I should also mention that FONTS will run on a Spectrum, and it is also reported that font sets in this package will work with PIXEL PRINT (Stan Lemke), but I haven't personally tested this.

PRICE: \$19.95 + \$3 S/H. FROM: Byte Power, 1748 Meadowview Ave., Pickering, Ontario, Canada, L1V-3G8.

Figure 1. Actual Screens from 1st Class Fonts II

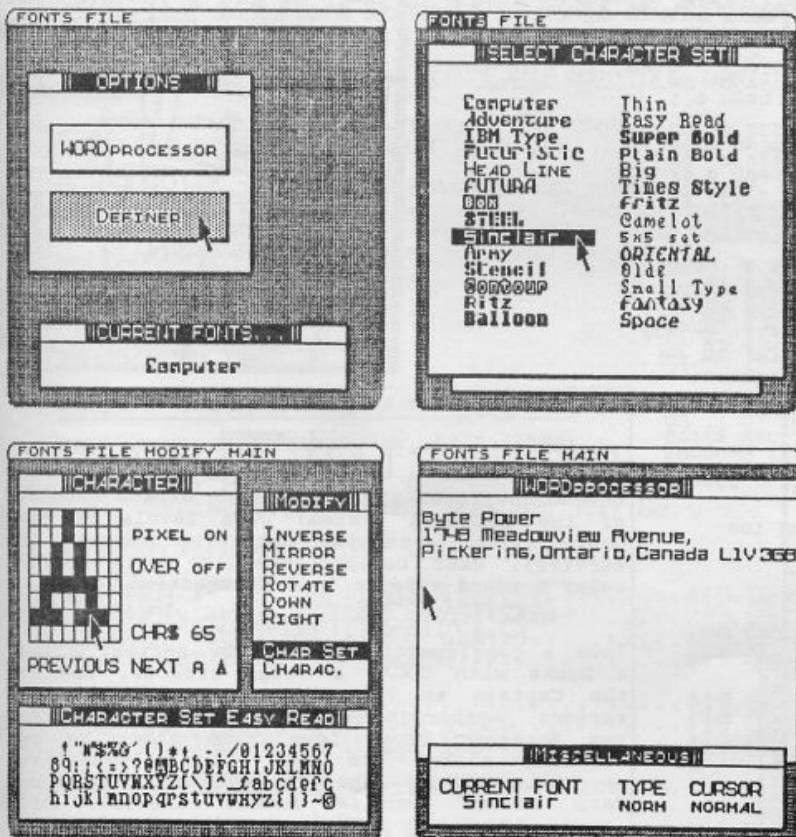

2068 GRAPHIC GOODIES

Stan Lemke



Here are a couple of little GRAPHIC GOODIES that won't take hours to type in, but demonstrate some neat graphic capabilities on the TS2068! BLINK uses the 2068's dual display mode to switch quickly between two pictures to make it appear as if part of the picture is blinking. The PAUSE in Line 800 varies as the counter "I" changes...so the drawing blinks slowly at first, and then speeds up. The length of the BEEP also changes to augment the effect. Just type it in. SAVE with RUN 900, and start the program with RUN(ENTER).

BOUNCE is a little simpler. The idea here is to place a picture on the screen, and have it move smoothly left/right a pixel at a time, creating the appearance of bouncing back and forth. Type the program in, SAVE with RUN 850, and start it with RUN(ENTER).

```
100 REM *****
      BLINK
      "Graphics Goodies"
      © by S D Lemke 1988
      Lemke Software Development
      2144 White Oak
      Wichita, Ks. 67207
```

```
100 REM *****
      BOUNCE
      "Graphics Goodies"
      © by S D Lemke 1988
      Lemke Software Development
      2144 White Oak
      Wichita, Ks. 67207
```

```
*****
150 DATA 45,0,52,1,211,244,219,
255,203,255,211,255,52,5,245,251
205,142,14,0,219,255,203,191,21
1,255,175,211,244,241,254,128,32
4,50,91,104,251,201,33,0,54,17,
0,95,1,0,27,237,178,201
200 FOR i=23383 TO 23433: READ
a: POKE i,a: NEXT i: RANDOMIZE U
SR 23383: OUT 255,0
250 PAPER 7: BORDER 7: INK 0: C
L5
300 PRINT AT 5,12:"Blink"
350 PLOT 50,110: DRAW 154,0: DR
AW 0,-100: DRAW -154,0: DRAW 0,1
00
400 PLOT 51,109: DRAW 152,0: DR
AW 0,-98: DRAW -152,0: DRAW 0,98
450 PLOT 53,107: DRAW 148,0: DR
AW 0,-94: DRAW -148,0: DRAW 0,94
500 RANDOMIZE USR 23422: OUT 25
5,1
550 PLOT 154,100: DRAW -122,-24
: PLOT 154,100: DRAW -56,-24: PL
OT 154,100: DRAW -64,-40: PLOT 1
84,100: DRAW -26,-40: PLOT 184,1
00: DRAW 0,-64
600 PLOT 60,74: DRAW 55,0: DRAW
0,-15: DRAW -55,0: DRAW 0,15
650 PLOT 72,53: DRAW 84,0: DRAW
0,-15: DRAW -84,0: DRAW 0,15
700 PLOT 92,42: DRAW 92,0: DRAW
0,-15: DRAW -92,0: DRAW 0,15
750 PRINT AT 13,8:"Lemke":AT 15
,10:"Software":AT 17,12:"Develop
ment"
800 FOR i=35 TO 2 STEP -2: OUT
255,0: BEEP .001*i,30: OUT 255,1
: PAUSE (1/2): NEXT i: FOR i=1 T
O 5: OUT 255,0: BEEP .005,30: OU
T 255,1: NEXT i: OUT 255,0
850 STOP
900 SAVE "BLINK" LINE 100
```

```
*****
150 DATA 33,255,37,14,32,157,20
3,22,43,13,32,250,52,53,168,32,2
42,201,0,0,33,0,84,14,32,157,203
,30,35,13,32,250,52,53,168,32,24
2,201
200 FOR i=23425 TO 23463: READ
a: POKE i,a: NEXT i
250 PAPER 7: BORDER 7: INK 0: C
L5
300 PRINT AT 5,13:"Bounce"
350 PLOT 50,110: DRAW 154,0: DR
AW 0,-100: DRAW -154,0: DRAW 0,1
00
400 PLOT 51,109: DRAW 152,0: DR
AW 0,-98: DRAW -152,0: DRAW 0,98
450 PLOT 53,107: DRAW 148,0: DR
AW 0,-94: DRAW -148,0: DRAW 0,94
500 PLOT 154,100: DRAW -122,-24
: PLOT 154,100: DRAW -56,-24: PL
OT 154,100: DRAW -64,-40: PLOT 1
84,100: DRAW -26,-40: PLOT 184,1
00: DRAW 0,-64
550 PLOT 60,74: DRAW 55,0: DRAW
0,-15: DRAW -55,0: DRAW 0,15
600 PLOT 72,53: DRAW 84,0: DRAW
0,-15: DRAW -84,0: DRAW 0,15
650 PLOT 92,42: DRAW 92,0: DRAW
0,-15: DRAW -92,0: DRAW 0,15
700 PRINT AT 13,8:"Lemke":AT 15
,10:"Software":AT 17,12:"Develop
ment"
750 FOR j=1 TO 8: RANDOMIZE USR
23425: NEXT j: FOR i=1 TO 4: FO
R j=1 TO 16: RANDOMIZE USR 23445
: NEXT j: FOR j=1 TO 16: RANDOIMI
ZE USR 23425: NEXT j: NEXT i: FO
R j=1 TO 8: RANDOMIZE USR 23445:
NEXT j
800 STOP
850 SAVE "BOUNCE" LINE 100
```

<< CKTYPE REPORT >>

| | | |
|-----|-----|-------|
| 100 | 345 | 25200 |
| 150 | 431 | 43151 |
| 200 | 71 | 10331 |
| 250 | 203 | 10723 |
| 300 | 207 | 10710 |
| 350 | 209 | 10725 |
| 400 | 205 | 10345 |
| 450 | 205 | 10316 |
| 500 | 203 | 10340 |
| 550 | 209 | 13107 |
| 600 | 203 | 4434 |
| 650 | 203 | 4511 |
| 700 | 203 | 4545 |
| 750 | 200 | 6835 |
| 800 | 206 | 15459 |
| 850 | 19 | 465 |
| 900 | 19 | 1697 |

<< CKTYPE REPORT >>

| | | |
|-----|-----|-------|
| 100 | 347 | 25411 |
| 150 | 353 | 15347 |
| 200 | 333 | 4493 |
| 250 | 209 | 1972 |
| 300 | 209 | 2145 |
| 350 | 205 | 5320 |
| 400 | 205 | 5846 |
| 450 | 205 | 5815 |
| 500 | 209 | 13107 |
| 550 | 203 | 4434 |
| 600 | 203 | 4511 |
| 650 | 203 | 4545 |
| 700 | 203 | 6835 |
| 750 | 16 | 15378 |
| 800 | 20 | 465 |
| 850 | 20 | 1931 |

BINGHAM'S BEST+ !!

COLLECTION ON CASSETTE \$12.95 ppd

Ultra-Easy Designer Graphics

3088 WINDOWS

CLASSY

and includes Windows & Portfiles

Send to: PAUL BINGHAM PO Box 2034 Mesa, AZ 85214

NEW SOFTWARE FOR YOUR TS2068

(Applied On Cassette)

BATTLESTAR XEMIT(9K):

Defend the fleet against suicide attack fighters of the Denebola System! Nine levels of play where skill & tactics determine success and survival. User Defined Graphics with special color & sound effects in a fast-action arena!

START-REK(16K):

Face a conglomeration from the series, films, & books with UDG's & sound effects. YOU are the Captain as The Ship is confronted with various scenarios which you must resolve. Ten Screens; Seven Levels of play; No two sessions alike! Use the 'Kirk Alternative' as you command Phasors, Photon Torpedoes, Warp Drive, Impulse Power, Shields, etc.

SEND \$9 FOR EACH TO:

VP HOSEY·Box 135·Red Rock·TX·78662

PAUL BINGHAM EVALUATES THE Z88

IS THE NEW COMPUTER TOO MUCH OF A BREAK FROM TRADITION?

Some grumbling as to whether the new Z88 laptop computer should be included in the "Sinclair family" have fallen on my ears and perhaps yours. It has a new operating system, including of all things, BBC BASIC, and it does not load ZX81, 2068 or QL software. So has Sir Clive invented too much of a maverick? a look backward may be the best way to answer this.

As a card-carrying pack rat I am privy to something many are denied: history. In perusing through all the old SYNC, E. Arthur Brown catalogs, and other innumerable goodies I have hung on to all these years, I was able to see Sinclair's U.S. history. I thumbed through all the old ads from 1983 and found just what was being offered for the ZX81 and TS1000. 64K add-ons were hot. A system called "Basicare" even offered a bank-switching add-on and 64K modules for up to 1 Megabyte (Mb) of RAM (for big bucks). Memotech had some software on EPROM: just plug in and go! But the hottest upgrades were KEYBOARDS. I've charted average prices on peripherals for each machine (within the first six months of release for most things) in Figure B.

As 1984 began, so did the excitement over the new arrival: Sir Clive's Spectrum reworked and expanded as the TS2068. And just as everyone was ordering their

unit from Sears, Timex threw in the towel. Ever wonder what would have happened if they had stuck by it? After all, the Spectrum with 128K and a built-in disk drive is still in production and selling in merry old England. Well, Sinclair users circled the wagons. Third-party producers kept giving us the peripherals we needed. And in late 1985, after months of rumors, the QL was unveiled. But it wasn't really a grown up Spectrum: it was something brand new. We bought them here, but not like they did in Europe. Then the flat-screen TV and electric car bills caught up with Uncle Clive. And in the Summer of 1986, he saved the family by selling the farm. The new owner said, "Spectrum: yes, QL: no."

Now, after three years since the QL was released Sinclair's team (renamed "Cambridge" after the place they've always been) show us what they've been working on: the Z88. But the remaining Sinclair users are older and wiser now. Some healthy skepticism requires we take a careful look before we buy. Upon close examination we find some interestingly familiar Sinclair touches. The unit is small, definitely from up Sir Clive's alley. After calculators, watches, ZX80s and 81s, he's back to home turf. And this time there's actually a category in

(716) 834-1716

T & C SERVICES
20 LIBERTY TERRACE
BUFFALO, N.Y. 14215

(716) 834-1716

Call or write for a free catalog of products for the Timex Computer

BYTE POWER 1ST CLASS MAGAZINE

BYTE POWER IS A HIGHLY SOPHISTICATED COMPUTERIZED MAGAZINE ON CASSETTE FOR THE TS2068 AND SINCLAIR SPECTRUM 48K.

NO LONGER WILL YOU HAVE TO TYPE IN LONG, FASTIDIOUS PROGRAMS... JUST LOAD AND RUN!

BYTE POWER IS THE ULTIMATE MAGAZINE, OVER 110 PROGRAMS WERE PUBLISHED UP TO NOW. MOST OF THESE ARE IN FAST MACHINE CODE! AND WE BRING YOU THIS QUALITY PROGRAMMING AT A VERY SMALL COST:

| | | |
|------------------------|---------|----|
| 1 ISSUE..... | \$5.99 | PP |
| 6 ISSUES..... | \$32.00 | PP |
| 12 ISSUES..... | \$55.00 | PP |
| CATALOG/DEMO TAPE..... | \$3.00 | PP |

1ST CLASS PACK (6 ISSUES IN ALBUM)..\$37.00+\$3 S/H

ISSUES AVAILABLE...(AS OF JULY 1988)

AUG 86, SEPT 86, OCT 86, NOV 86, DEC/JAN 87,
 FEB 87, SPRING 87, FALL 87, FEB 88, MAY 88.

ALSO AVAILABLE FROM BYTE POWER...

| | |
|---|---------|
| BYTE POWER 1ST CLASS FONTS II..... | \$19.95 |
| BYTE POWER 1ST CLASS PROGRAMS (ZX81)..... | \$9.95 |
| THE D.U.S. V2.0 (FOR LKDOS CART.)..... | \$29.95 |
| 2+FAST (FAST LOAD FOR TS2068)..... | \$19.95 |

| | |
|---------------------------------------|---------|
| BEST OF ARCADE GAMES..... | \$19.95 |
| BEST OF STRATEGY AND BOARD GAMES..... | \$19.95 |
| BEST OF BUSINESS AND UTILITIES..... | \$19.95 |

PLEASE ADD \$3.00 PER SOFTWARE FOR SHIPPING.

ALL PRICES IN U.S. FUNDS ONLY PLEASE.

BYTE POWER Magazine ** JUST LOAD AND RUN!

YES, A FAST LOAD FOR THE TS2068!

IT WILL LOAD BASIC, CODES AND ARRAYS UP TO 2.5 TIMES FASTER!

VERY EASY TO USE!

FEATURES 3 MODES:

| | |
|----------------|--|
| SPEED 1 (Norm) | |
| SPEED 2 (*2) | |
| SPEED 3 (*2.5) | |

COMES IN A HIGH QUALITY VINYL ALBUM WITH SUPERB MANUAL.

\$19.95 (US)
 + \$3.00 S/H

FOR DETAILED INFORMATION ABOUT ANY OF OUR PRODUCTS PLEASE SEND \$3 (US) FOR OUR COMPLETE DEMO/CATALOG PACKAGE.

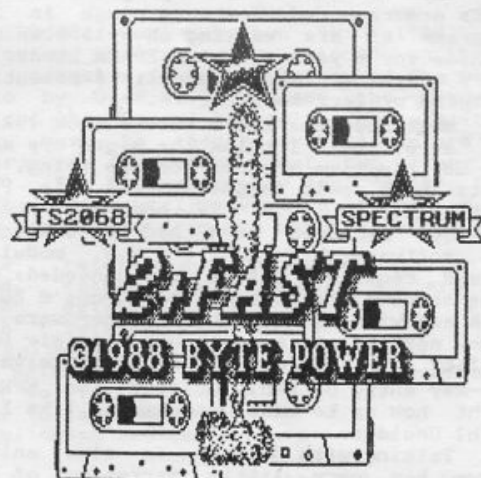

THE magazine for the TS2068!

Send \$3.00 for DEMO/CATALOG

BYTE POWER
MAGAZINE

1748 Meadowview Avenue
 Pickering, Ontario, Canada
 L1V 3G8

computerdom for his latest invention called "laptops". It is distinctively Sinclair black. It has a water-resistant keyboard, too. All the keys are normal enough but each is connected underneath by a rubber membrane to repel fluids. Is there a Serial Port? You bet. And a rear edge connector? Yes, but it is on the side this time. Is there an on/off switch? Well, no switch, but pressing both SHIFT keys at the same time turns it on. Figure A details more Sinclair machine comparisons.

The Z88 has sound, but harking back to the days of the ZX81 and TS1000, there are only four chips. One is a whopping 128K ROM chip that holds the operating system and five built-in programs. Another is the 32K RAM which would have made TS1000 owners drool, but is limiting now as their 2K RAM was back then. The user can easily upgrade this computer to an amazing 3Mbs providing he can afford it (for more on that see Figure C). The third chip is a custom gate array made by NEC. But the fourth and final chip is what really proves Sir Clive came home: the Z80 CPU. All of his computers have had a Z80 with the exception of the QL (which implemented the fundamentally different 68000 CPU chip). The Z80 is the "Cadillac" among 8-bit CPUs. This Z80 is a special CMOS type, meaning it is very low power consumptive, but otherwise uses the same machine code all Sinclair hackers are accustomed to. The Z88 even has a built-in assembler for us! And somehow Sir Clive has managed to make the four chip Z88 computer plenty fast. I've been impressed by its speed and also its ability to jump mid-stream from one program to another, call up menus with a key press and then return without a hitch. The Z88 does act in some ways like the QL, too.

The Z88 has many of the good features from his previous machines. And it has a few new surprises as well. The built-in (no-need-to-load) programs are very good. The word processor trounces the QUILL program the QL came with. And as a previously dedicated "Day-Timer" daily schedule book user, I am particularly pleased with the calendar feature. It will automatically transfer today's task to tomorrow's list of things to do if you haven't completed it. The choice to go with what amounts to RAM disk technology instead of floppies or microdrives for storage will raise some eyebrows. But certainly a whole range of disk and even cassette based storage options are coming. The Z88 will change the way we think about programs. No LOADING or long SAVES are required. Software plugs in instantly, and programs we are working on will stay unharmed in the machine for a year. With an EPROM burner built in to every machine, every user is a potential EPROM-based software writer, too!

What does the Z88's future look like? I don't know for sure, but I think the signs are more encouraging for us this time around. For one thing, Sir Clive's big debts were paid in the Amstrad sale. For another this machine has no "U.S. TV hook-up" problems all his previous machines have had to overcome. The special U.S. software, U.S. ROMs and U.S. modulator circuitry always required before are unneeded: we all have the same screens! So most all of Europe's Z88 software will work and vice versa. Ditto for hardware. That brings me to my next point: even though Sinclair was forced into selling his BASIC, isn't it conceivable that even a one-key entry of BASIC utility (on EPROM of course) might how up to make programming like I'm most at home with? Could be.

Talking with dealers is also enlightening. Sir Clive has very little marketing of the new machine going on in the U.S. as of yet. He's pushing it at home, presumably to get it going strong overseas. If we were seeing the big magazine ads and slick-paper mailings we received with his previous machines, I'd be worried. Perhaps he has learned some austerity in the last few years. They are also holding the line on prices. They are determined that the mad fury of gas-war style price cutting that derailed the TS1000 will not sink the Z88, too. We are also seeing Clive promote the machine himself. This is not to save money on sales help, but I believe the man for the first time in a long time is truly proud of a creation. And rightly so. The Z88 belongs in the "Sinclair Family".

SINCLAIR COMPUTERS SPECS:

| Figure A. | ZX81/TS1000: | TS1500: | TS2068: | QL: | Z88: |
|-----------------|--------------|-----------|------------|------------|------------|
| CPU | Z80A | Z80A | Z80A | 68008 | Z80A(CMO) |
| FOOTPRINT | 6.5"x6.9" | 9"x5.6" | 14.5"x7.5" | 18.6"x5.4" | 11.4"x8.1" |
| UNIT THICKNESS | 1" | 1.2" | 1.3" | 1.8" | .9" |
| VOLUME | 45 cu ins | 63 cu ins | 136 cu ins | 176 cu ins | 85 cu ins |
| WEIGHT | 12 oz. | 19 oz. | 39.5 oz. | 49 oz. | 31.5 oz. |
| KEYBOARD SIZE | 5.8"x1.9" | 8.4"x2.3" | 8.8"x3.5" | 12.2"x3.7" | 11.2"x3.1" |
| NUMBER OF KEYS | 40 | 40 | 42 | 65 | 64 |
| SPACE KEY LEN | .43" | 1" | 5.2" | 5.2" | 5.2" |
| INITIAL MEMORY | 2K | 16K | 72K | 128K | 32K |
| MAX (UNALTERED) | 64K | 64K | 16Mb | 1Mb | 3Mb |
| ROM PORTS | 0 | 0 | 1 | 1 | 3 |
| SERIAL PORTS | 0 | 0 | 0 | 2 | 1 |
| JOYSTICK PORTS | 0 | 0 | 2 | 2 | 0 |
| MONITOR OUTPUT | N | N | Y | Y | N |
| TV OUTPUT | Y | Y | Y | Y | N |
| SCREEN PIXELS | 2816 | 2816 | 45056 | 131072 | 40960 |
| NO. CHARACTERS | 704 | 704 | 1408 | 2000 | 848 |



SINCLAIR COMPUTERS AND PERIPHERALS:

| Figure B. | ZX81/TS1000: | TS2068: | QL: | Z88: |
|--------------------|--------------|---------|-------|-------|
| COMPUTER | 99.- | 190.- | 300.- | 480.- |
| BUNDLED SW INCL | 0 | 3 | 4 | 5 |
| ADD 16K RAM | 43.- | - | - | - |
| ADD 32K RAM | 98.- | 110.- | - | 42.- |
| ADD 64K RAM | 135.- | 130.- | - | 83.- |
| ADD 128K RAM | 420.- | 176.- | - | 98.- |
| ADD 256K RAM | 720.- | 198.- | 220.- | 195.- |
| ADD 512K RAM | 1320.- | - | 403.- | 385.- |
| CONTR & 1 DDRIVE | 479.- | 373.- | 330.- | 200.- |
| EPROM BASED SW | 50.- | 30.- | 72.- | 46.- |
| EPROM PROG CIRCUIT | 60.- | 34.- | 120.- | 1NCL |
| MODEM COMPLETE | 150.- | 115.- | 281.- | 200.- |
| PAR PRINT I.F. | 72.- | 65.- | 49.- | 61.- |

Z88 THIS COMPACT.

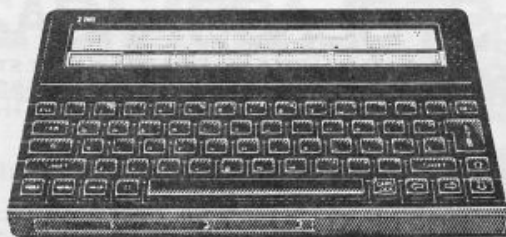

THIS POWERFUL...

- The most portable full-function computer ever devised.
- Less than an inch thick, measures 11 1/2 in. x 8 1/4 in. Weighs under 2 lb.
- Comes complete with integrated set of powerful applications software: word-processing, spreadsheet, database, calculator, diary, calendar, clock, alarm, printer editor... all included in ROM.
- Can export, import and manipulate data from IBM-compatible PCs; converts its own applications software into Wordstar or Lotus 1-2-3 files. Mac and ST, QL Linkups available also.
- Extra memory comes in solid-state, interchangeable packs... only 2 1/2 in. square x 1/8 in. deep. No fragile disks, no bulky disk drives.
- 32K of RAM built in, expandable to 3 megabytes soon... enough to hold the complete works of Shakespeare.
- Permanent storage on EPROM (Erasable Programmable Read Only Memory) packs, available in 32K and 128K. 1 megabyte packs coming soon.
- Latest supertwist liquid crystal display provides large working area of 8 lines x 80 characters.
- RS232 port provides connection to virtually any standard printer.
- QWERTY keyboard has silent, short-travel keys: use in meetings, lectures, anywhere.
- Runs on four AA batteries. Built-in capacitor preserves data when batteries need to be changed.

Z88 SOFTWARE IN ACTION

The Z88's ingenious built-in software suite lets you switch any two applications... even word processing and spreadsheet... without loading separate software into the computer's memory.

Switch from writing a letter to find an address... from composing a report to carrying out a calculation... move a spreadsheet into a document... simply press a couple of keys!

Z88 Sinclair Computer \$479.95
68008 Sinclair QL \$149.95
Call or write for other Z88 products

SHARP'S Inc.

Box 326
Mechanicsville, VA 23111
(804) 730-9697 9am - 4pm



| Figure C. | ZX81/TS1000: | TS2068: | QL: | Z88: |
|-----------|--------------|---------|------|------|
| MEMORY | 16K | 2.69 | - | - |
| | 32K | 3.06 | 3.44 | 1.31 |
| UPGRADE'S | 64K | 2.11 | 2.03 | 1.31 |
| COST PER | 128K | 3.28 | 1.38 | .77 |
| | 256K | 2.81 | .77 | .76 |
| BYTE: | 512K | 2.58 | - | .79 |

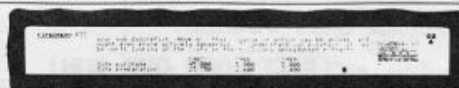

RESIDENT PROCEDURES

Michael E. Carver

One of the many powers lurking within the QL is the ease of extending SuperBASIC. The simplest means of doing this is by defining PROCedures or FuNctions within a SuperBASIC program. The newly defined PROCEDURE or FuNction is then treated as a SuperBASIC keyword (i.e., PRINT, MODE, SAVE, CODE, etc.). A more sophisticated and global approach is to "link" the new PROCEDURE or FuNction to the system's resident memory. In other words, create a semi-permanent extension to SuperBASIC. With this method, any linked keyword is available no matter what program is residing in the computer. As long as another PROCEDURE or FuNction is not DEFINED with an identical name and the computer is not reset, these keywords are available for use by any program, or by direct command.

Let's take a few seconds and review the difference between a PROCEDURE and a FuNction. Simply put, a PROCEDURE will preform a task and a FuNction will return a value or alter a variable. (EXAMPLE: CLS is a PROCEDURE and INKEY\$ is a FuNction.) These guidelines are not strictly followed by QDOS however. It is even possible to redefine certain SuperBASIC keywords. The most recent DEFINITION takes precedent over earlier definitions. There are, however, certain keywords which QDOS will not redefine:

END, FOR, IF, REPEAT, SELEct, WHEN ERROR, DEFine, PROCEDURE, FuNction, GO TO, GO SUB, WHEN EOF, INPUT, RESTORE, NEXT, EXIT, ELSE, ON, RETURN, REMAINDER, DATA, DIM, LOCAL, LET, THEN, STEP, REMark, and MISTake

If one is writing a SuperBASIC program in its proper fashion (i.e., modules of PROCedures and FuNctions), it can be very easy to lose one's bearings. Since a call to a PROCEDURE or FuNction is not indexed via a Line #, as in most BASICs, it would be helpful to have a routine to provide a "map" of the SuperBASIC program. While we are at it, why not list the variables and arrays? That is precisely what the PROCEDURE we are going to write will do. VDUMP will provide a list of all variables and arrays, along with PROCedures and FuNctions, including the Line Number where the DEFINITION took place. (See Table 1 for an example.)

We will be using some of the lessons learned in past issues of TIME DESIGNS (March/April & May/June '88; "Mandelbrot--A Fractal World" parts III & IV), specifically, the areas involving the System Variables BV_NTBAS and BV_NLBAS (Name Table and Name List) and the areas of memory they point to. Our PROCEDURE will scan through these areas of memory and report on what it finds.

Let's examine the means for linking in PROCedures and FuNctions. QDOS provides us with a system utility to do just that, BP_INIT add PROCedures and FuNctions to SuperBASIC (vector \$110). Upon entry the following registers must be set accordingly:

| | | | |
|---|--|----|--|
| A1 | start of PROCEDURE/FuNction list | | |
| A6 | usual SuperBASIC address of SuperBASIC variables | | |
| Upon exit the following registers are affected: | | | |
| D1 | preserved | A0 | preserved |
| D2 | preserved | A1 | corrupted |
| D3 | corrupted | A2 | preserved |
| | | A3 | preserved |
| | | A6 | may be updated if more memory was required |

Errors: None

The above utility will add the defined PROCedures and FuNctions to the QL's system. The required format is as follows:

```
dc.w procnum      number of PROCedures to be added
;
; for each PROCEDURE to be created the following --
;
dc.w proutine-*   relative pointer to PROCEDURE routine
dc.b proclen     length of the PROCEDURE name
dc.b 'proc_name' name of the PROCEDURE in ASCII
;
; then at the end of the PROCEDURE list --
;
dc.w 0
dc.w funcnum     number of FuNctions to be added
```

```
; for each FuNction to be created the following --
;
dc.w froutine-*   relative pointer to FuNction routine
dc.b fnlen       length of the FuNction name
dc.b 'fun_name'  name of the FuNction in ASCII
;
; then at the end of the FuNction list --
;
dc.w 0
```

Be advised if your PROCEDURE/FuNction names are long (with an average of over 8 bytes), the values for "procnum" and "funcnum" should be calculated using the following formula:

$$\frac{(\text{number of PROCedures} + \text{number of FuNctions} + \text{number of bytes used in all names} + 7)18}{18}$$

Any errors in the above format will more than likely cause a serious system crash. It is important that this format be followed closely. Even if you are only creating PROCedures (as in our example), the information for FuNctions must be included, especially the 0's following the list of both the PROCedures and FuNctions. (See Listing 2 - label "procs".)

We are now ready to add a semi-resident PROCEDURE to QDOS. (Ask anyone with an IBM or clone if they can pull off such a trick as easily as our beloved QL can!)

VDUMP will display (or print) a list of SuperBASIC variables, PROCedures, and FuNctions to any channel the user specifies, providing the channel is open. In order to redirect this information to a channel, other than the default channel (#1), a parameter declaring that channel must be passed to the PROCEDURE routine. This is accomplished by following the same format as other SuperBASIC commands (i.e., "#" followed by the number of the channel). QDOS provides us with another of its wonderful system utilities to help us.

vardump

Whenever a PROCEDURE or FuNction is called, any parameters following the name are placed on the RI stack. The first parameter is on the bottom of the stack and pointed to by 0(a6.a1.1). Since the argument separators are lost when one of the following utilities is called, they must be checked or saved before the parameter is retrieved (see the first two lines at label "vardump"). The separators may include "#", ";", ",", "\", etc. The system utility vectors that can be used to retrieve parameters from the maths/RI stack are:

| | | | |
|--|---------------------------------|----|------------------------------|
| CA_GTINT -- \$112 | retrieve word integers | | |
| CA_GTFP -- \$114 | retrieve floating point numbers | | |
| CA_GTSTR -- \$116 | retrieve strings | | |
| CA_GTLIN -- \$118 | retrieve long integers | | |
| Upon Entry the following registers should be set accordingly): | | | |
| a1.1 | top of maths stack | | |
| a3.1 | pointer to first parameter | | |
| a4.1 | pointer to last parameter | | |
| Upon Exit the following registers are affected: | | | |
| d1 | corrupted | a0 | corrupted |
| d2 | corrupted | a1 | updated pointer top of stack |
| d3.w | no. of parameters | a2 | corrupted |
| d4 | corrupted | a3 | preserved |
| d6 | corrupted | a4 | preserved |
| | | a5 | preserved |
| Errors: | | | |
| -15 | bad parameter | | |
| -17 | error in expression | | |

After we save the parameter separator, we use CA_GTINT to retrieve any possible parameter (i.e., "VDUMP #3"). If there are no errors and only one parameter was found, a check is carried out to see if parameter separator was "#" (see "assign"). A check is then carried out to verify that such a channel is open and the internal channel ID is stored in a0. If no parameter is found, the default channel #1 is assigned ("default"). (NOTE: Please refer to the discussion of channel ID's in the "Mandelbrot" Part III article; Plotter Source Code section "ink".) The lines in the VDUMP code labeled "assign, starting with "move.1 BV_CHBAS (a6),a2" through label "no_chan", is the method of ascertaining the correct internal channel ID number based on the SuperBASIC channel ID.

The rest of the PROCEDURE is rather simple and straightforward. Most of the work performed by this PROCEDURE is similar to our machine code routine in the Mandelbrot program that searched the SuperBASIC variables area for the two variables assigned in BASIC. (See text and source code labeled "calc" along with Table 1 - Variable Types.)

Let's now examine the various system utilities used by this PROCEDURE to print the information and messages. The first vector used is UT_MTEXT - \$d0 - print message on channel. Upon entry, the following registers must be set:

```
a0.1 channel ID
a1.1 start of message
```

Upon exit the following registers are affected:

```
d1 corrupted a0 preserved
d2 corrupted a1 corrupted
d3 corrupted a2 preserved
a3 preserved
```

Errors: Any error from I/O operations (see pages 19-20 of the Concepts section of the QL User's Guide for a list of Error Codes).

The message pointed to by a1 is sent to the specified channel. The correct format of the message pointed to by a1 is:

```
dc.w mess_len length of message -- must be word length
dc.b 'message'
```

It is wise to ensure that the length of the message definition block end on a word boundary, since the CPU expects all addresses to begin on even addresses. (See Listing 2, label "line_mess".)

Another means of printing to a channel is by using the Trap #3 utility, IO_SSTRG - \$07 - send sequence of bytes to channel. Upon entry the following registers must be set accordingly:

```
d2.w number of bytes to send
d3.w timeout
a0.1 channel ID
a1.1 location of first byte to send
```

Upon exit the following registers are affected:

```
d1.w no. of bytes sent a0 preserved
d2 preserved a1 1 past last byte sent
d3 preserved a2 preserved
a3 preserved
```

Errors:

```
-1 not complete
-6 invalid channel ID
-11 drive full
```

This trap will send as many bytes as it can (which are pointed to by a1) during the timeout specified. NOTE: Timeouts are similar to those used by SuperBASIC in such FuNctions as INKEY\$ (24) or INKEY\$ (-1).

VDUMP also uses another Trap #3 utility to send just one byte to a channel, IO_SBYTE - \$05. Upon entry set the following registers:

```
d1.b byte to be sent
d3.w timeout
a0.1 channel ID
```

Upon exit the following registers are affected:

```
d1 corrupted a0 preserved
d2 preserved a1 corrupted
d3 preserved a2 preserved
a3 preserved
```

Errors: same as IO_SSTRG

It is also possible to send a decimal number to a channel by using the utility vector UT_MINT - \$ce. Upon entry set the following registers:

```
d1.w value to print
a0.1 channel ID
```

Upon exit the following registers are affected:

```
d1 corrupted a0 preserved
d2 corrupted a1 corrupted
d3 corrupted a2 corrupted
a3 corrupted
```

Errors: all possible I/O errors

GETTING VDUMP INTO THE MACHINE

Carefully key-in Listing 1 into your computer and save to cartridge or disk before running. I have included error checks in an attempt to catch any mistyped numbers which make up the machine code routine. After you have saved the program, simply RUN the SuperBASIC. It will POKE into memory the machine code and save itself to your specified device (i.e., mdv1_, flp1_, etc.). NOTE: The command RESPR will not work if another job besides SuperBASIC is resident in the QL.

USING VDUMP

The easiest way to link-in our new PROCEDURE is to incorporate Listing 3 into your normal boot program (be sure to change Line numbers so as not to overwrite any lines already in your boot program). Once the QL has been "booted" with this new PROCEDURE, the simple command of "vdump" will list all variables, arrays, PROCEDURES or FuNctions to the default channel (#1). By pressing CTRL F5, the display to the screen can be halted. Pressing any key will reactivate the PROCEDURE. It is possible to send your "vdump" to a file on a disk or cartridge by first opening a file (OPEN_NEW #7, mdv1_dump), and then using the command "vdump #7". Be sure to close the file when the PROCEDURE has returned the flashing cursor (CLOSE #7). You can also send a list of your SuperBASiC variables, PROCEDURES and FuNctions to your printer. First, open the serial port connected to your printer via (OPEN_SERiC, #7). The "c" insures that QDOS linefeeds (ASCII 10) are sent to your printer as carriage returns (ASCII 13). The command "vdump #7" will now send the listing to your printer.

I hope that this PROCEDURE will be an aid in creating fantastic SuperBASIC programs and will provide another "open door" to exploring the POWER and VERSATILITY of the QL. All other less sophisticated computers BEWARE...we are taking the "Quantum Leap"!

SUGGESTIONS

For the more adventurous souls, the next logical step would be to alter the procedure to print out the values of the variables and the dimension data for the arrays. With this added feature to VDUMP (now called XDUMP), writing and debugging SuperBASIC programs will become less of a chore. By placing XDUMP in a program line where you suspect some "bugs", a complete value listing of all the declared variables can be checked (i.e., 2002 PRINT #5; "LINE #2002": XDUMP #5).

For those who do not have the time or the inclination, I will provide such embellishments on microdrive cartridge or floppy disk for an extra \$2.50 charge. I will also include QUILL files of this article, along with all supporting programs and source code. To receive VDUMP and/or XDUMP (which will display variable values and array dimension information), send a check or money order for \$7.50 (+ \$2.50 for XDUMP) to: Michael E. Carver, 1016 N.E. Tillamook, Portland, OR 97212. Or \$4.00 (+ \$2.50 for XDUMP) if you provide your own cartridge or disk. Please specify what format you wish (only microcartridge and 5 1/4" DS/DD disk available).

LISTING 1 -- Machine Code Loader for vdump

```
10 REMark **** Program to Load 'vdump' procedure
20 REMark **** as machine code and save to device
30 REMark ****
40 REMark ****
50 :
60 checking
70 device
80 into_machine
90 to_medium
```

* SHARP'S INC. *
 BOX 326
 MECHANICSVILLE, VA 23111
 (804) 730-9697

SINCLAIR QL

\$10 OFF

SPECIAL OFFER FOR TDM READERS ONLY

\$149.95 (+ \$10 S&H) Regular Price
 \$139.95 (+ \$10 S&H) With Coupon

OFFER EXPIRES JANUARY 15, 1989

* COUPON *
 * COUPON *
 * COUPON *
 * COUPON *

CLIP COUPON OR PHOTOCOPY

LIMIT 2 PER CUSTOMER

```

100 test
110 :
120 DEFINE PROCEDURE into_machine
130 CLS: PRINT "\"POKEing code into memory. . ."
140 a=RESPR(332)
150 b=a
160 RESTORE 1000
170 REPEAT load_loop
180 FOR x=0 TO 20
190 FOR y=1 TO 8
200 READ number
210 POKE_W (b),number
220 b=b+2: IF b>=a+332 THEN EXIT load_loop
230 END FOR y
240 READ number: REMark *** clear check_sum
250 END FOR x
260 EXIT load_loop
270 END REPEAT load_loop
280 END DEFINE into_machine
290 :
300 DEFINE PROCEDURE device
310 device#="mdv1_"
320 PRINT "Default device ";device#
330 PRINT "Change device to: "
340 INPUT "(PRESS Return to keep old device) ";newdevice#
350 IF newdevice#<>" THEN device#:=newdevice#
360 CLS: PRINT "Will save to ";device#
370 END DEFINE device
380 :
390 DEFINE PROCEDURE test
400 CLS: PRINT "Testing new procedure. . ."
410 DIM dummy(20)
420 CALL a
430 vdump
440 END DEFINE test
450 :
460 DEFINE PROCEDURE checking
470 CLS: PRINT "Checking DATA statements. . ."
480 RESTORE 1000
490 FOR x=0 TO 20
500 count=0
510 FOR y=1 TO 8
520 READ number: count=count+number
530 END FOR y
540 READ check_sum
550 IF check_sum<>count
560 PRINT "ERROR -- Check line # ";1000+x*10
570 STOP
580 ELSE
590 END FOR x
600 PRINT "DATA checked -- OKAY"
610 END DEFINE checking
620 :
630 DEFINE PROCEDURE to_medium
640 PRINT "\"Ready ";device#;" Press any key to Save. . ."
650 REPEAT loop
660 a#:=CHR$(ready)
670 IF a#<>" THEN EXIT loop
680 END REPEAT loop
690 SBYTES device#&"vardump_proc",a,332
700 END DEFINE to_medium
710 :
720 DEFINE FUNCTION ready
730 LOCAL x
740 c=CODE(INKEY#(-1))
750 RETURN c
760 END DEFINE ready
770 :
1000 DATA 12408,272,17402,6,20112,20085,1,14,70300
1010 DATA 1366,17493,19792,0,0,0,18938,300,57889
1020 DATA 6326,-18431,12408,274,20112,19072,26236,3139,69136
1030 DATA 1,27950,26372,28913,20085,2068,7,26614,132010
1040 DATA 12342,-26624,21678,88,9326,48,-16132,40,766
1050 DATA -10816,-18962,52,27654,8310,-22528,24586,28922,37218
1060 DATA 20085,8316,1,1,28672,17402,154,13432,88063
1070 DATA 208,20114,14396,2,24882,17402,152,13432,90588
1080 DATA 208,20114,14396,3,24866,17402,148,13432,90569
1090 DATA 208,20114,14396,4,24850,17402,148,13432,90554
1100 DATA 208,20114,14396,5,24834,20085,17390,28,97060
1110 DATA 10769,-9586,17390,32,10833,-9266,17390,24,37586
1120 DATA 10321,-9778,-18412,26370,24628,8781,-11540,2,30372
1130 DATA -19507,28458,5145,30463,28679,20035,3076,4,96353
1140 DATA 27924,17402,90,13432,208,20114,12844,4,92018
1150 DATA 13432,206,20114,29194,30463,28677,20035,20556,162677
1160 DATA -17780,27840,20085,12,2646,24946,26977,25196,109922
1170 DATA 25971,14858,10,2625,29298,24953,29498,8202,135415
1180 DATA 14,2640,21071,17253,25717,29285,29498,8202,133680
1190 DATA 12,2630,30030,25460,26991,28275,14858,9,128265
1200 DATA 8224,19561,28261,8227,8192,0,0,0,72465

```

LISTING 2 -- Source Code for Variable Dump PROCEDURE (vdump)

```

;
; title 'VDUMP'
; Procedure to Dump Variables, Procedures, and Functions
; produced in SuperBASIC
;
; written by Michael E. Carver 2/8/88
;
; revised 2/15/88
; final revision 6/19/88
;
; CTL F5 will halt display to screen
; To send to printer open seric or ser2c to provide
; Carriage Return
;
; register use d5=end of name table
; a5=start of list table
; d6=holds name table data
; d4=type searching for
; a4=pointer in name table
;
; Labels *****
LINEFEED equ $0a ASCII code for Line Feed
VARS equ $02 variable types
ARRAY equ $03 array types
PROC equ $04 Procedure types
FUNC equ $05 Function types
;
; The following labels may be supported by your assembler
;
BV_NTP equ $1c offset end of name table
BV_NLBAS equ $20 offset start of list table
BV_NTBAS equ $18 offset start of name table
CH_LENCH equ $28 length of channel block
BV_CHBAS equ $30 channel table
BV_CHP equ $34 end of channel table
BV_RIP equ $58 maths stack pointer
BP_INIT equ $110 add SuperBASIC Procedure
UT_MTEXT equ $d0 print message on channel
IO_SSTRG equ $07 send sequence of bytes to channel
IO_SBYTE equ $05 send byte to channel
UT_MINT equ $ce send decimal number to channel
CA_GTINT equ $112 get parameters as word integer
;
; *****
;
; Actual start of program as loaded into machine
;
install move.w BP_INIT,a0 link in procedure
lea procs,a1
jsr (a0)
rts
procs dc.w 1 number of procs
dc.w vardump-* relative locaiaon
dc.b 5,'VDUMP' procedure name
dc.w 0 end of procs
dc.w 0 number of functions
dc.w 0 end of functions
;
; routine to check for parameter & type if not "#" report
; parameter error
;
vardump lea par_sep,a4 save parameter separator
move.b 1(a6,a3.1),(a4)
move.w CA_GTINT,a0
jsr (a0)
tst.l d0 any errors?
bne.s exit quit if any
cmp.w #1,d3 one parameter?
blt.s default no parameter
beq.s assign if one, assign channel ID
moveq #-15,d0 incorrect parameters
rts return with error report
was '#' used?
assign btst #7,(a4)
beq.s bad_para
move.w 0(a6,a1.1),d0 get parameter
addq.l #2,BV_RIP(a6) restore maths stack
move.l BV_CHBAS(a6),a2 find start of channel
mulu #CH_LENCH,d0 ... definition block
adda.l d0,a2 absolute address
cmp.l BV_CHP(a6),a2
bge.s no_chan not in table
move.l 0(a6,a2.1),a0 new channel ID
bra.s start

```

```

no_chan  moveq #-6,d0      'channel not found'
        rts
;
;
default  move.l #10001,a0  channel #1
;
;
; list all SuperBASIC variables *****
;
start    moveq #0,d0
        lea.l vars_mess,a1
        move.w UT_MTEXT,a2
        jsr (a2)          print "Variables:"+LF
        move.w #VARS,d4
        bsr.s pointers
;
; list all SuperBASIC arrays *****
;
        lea.l array_mess,a1
        move.w UT_MTEXT,a2
        jsr (a2)          print "Arrays: "+LF
        move.w #ARRAY,d4
        bsr.s pointers
;
; list all SuperBASIC PROCedures *****
;
        lea.l proc_mess,a1
        move.w UT_MTEXT,a2
        jsr (a2)          print "PROCedures:"+LF
        move.w #PROC,d4
        bsr.s pointers
;
; list all SuperBASIC FuNctions *****
;
        lea.l func_mess,a1
        move.w UT_MTEXT,a2
        jsr (a2)          print "FuNctions:"+LF
        move.w #FUNC,d4
        bsr.s pointers
;
exit     rts              done
;
;
; enter with d4 containing type 02=variable
;                                     03=arrays
;                                     04=SuperBASIC procedure
;                                     05=SuperBASIC function
;
;
;
pointers lea BV_NTP(a6),a1      end of name table
        move.l (a1),d5
        add.l a6,d5            absolute address
        lea BV_NLBAS(a6),a1    start of list table
        move.l (a1),a5
        add.l a6,a5            absolute address
        lea BV_NTBAS(a6),a1    start of name table
        move.l (a1),a4
        add.l a6,a4            absolute address
;
;
; check for proper type
; enter:  d4 containing high byte of type ID
;         a4 pointing to type
;
search   cmp.b (a4),d4         check type
        beq.s match
        bra.s nope
;
; found proper type *****
; enter with a0.l = channel ID from parameter information
;
match    move.l a5,a1          calculate address in
        add.w 2(a4),a1        ... list table
        cmp.l a5,a1           if local variables
        ble.s nope            ... prevent overlap
        move.b (a1)+,d2       length of variable name
;
; a1 now points to ASCII string of variable name
;
        moveq #-1,d3           timeout
        moveq #IO_SSTRG,d0
        trap #3                send string
;
; print line # if Procedure or Function *****
;
; 4(a4) will point to next word in name table which will be
; the line number where the DEFINE took place
;

```

```

        cmp.b #4,d4
        bit.s newline
        lea.l line_mess,a1
        move.w UT_MTEXT,a2
        jsr (a2)              print "Line # "
        move.w 4(a4),d1       get line number
        move.w UT_MINT,a2     print line number
        jsr (a2)
;
newline  moveq #LINEFEED,d1    send linefeed
        moveq #-1,d3           timeout
        moveq #IO_SBYTE,d0
        trap #3
;
; update pointers and continue search
;
nope     add #8,a4              next item in table
        cmp.l a4,d5            reached end of table
        bge.s search          if not continue
        rts                    end reached
;
; Message tables *****
; Important: the spacing between quotes is crucial!
;
vars_mess dc.w 12
        dc.b LINEFEED
        dc.b 'Variables:'      no spaces
        dc.b LINEFEED
;
array_mess dc.w 10
        dc.b LINEFEED
        dc.b 'Arrays: '       1 space after colon
        dc.b LINEFEED
;
proc_mess dc.w 14
        dc.b LINEFEED
        dc.b 'PROCedures: '   1 space after colon
        dc.b LINEFEED
;
func_mess dc.w 12
        dc.b LINEFEED
        dc.b 'FuNctions:'     no spaces
        dc.b LINEFEED
;
line_mess dc.w 9
        dc.b ' Line # ',0     insure word boundary
;
; 2 spaces before Line
; 1 space after #
;
par_sep  ds.w 1                program variable

```

LISTING 3 -- Boot program to install vdump PROCedure

```

100 REMark **** boot to load vdump Procedure
110 REMark **** this procedure is called with channel
120 REMark **** i.e. <vdump #2>
125 REMark **** CTL F5 will freeze screen during dump
130 a=RESPR(332): LBYTES mdv1_vardump_proc,a
140 CALL a

```

TABLE 1 -- vdump of Listing 1

```

Variables:
a
b
number
device#
newdevice#
count
check_sum
a#
c
;
Arrays:
dummy
;
PROCedures:
checking Line # 460
device Line # 300
into_machine Line # 120
to_medium Line # 630
test Line # 390
;
FuNctions:
ready Line # 720

```

Text⁸⁷

An Advanced QL Wordprocessor

PART ONE

by Mike de Sosa

As I indicated in the Time Designs Tests section of the last issue, Software87's Text⁸⁷ wordprocessor for the QL is billed as a full-featured, WYSIWYG wordprocessor designed for easy use by amateurs, but ranks in user-friendliness somewhere between QL QUILL and The Editor. And, as the 60-pages documentation for this excellent software is not always clear or complete and as it is not really fully WYSIWYG, some additional instructions for use are considered necessary. (Later versions of Text⁸⁷ are supposed to contain a tutorial for its use, but these are not yet available). The following pertains to version 1.6 of Text⁸⁷.

Using Text⁸⁷

The Text⁸⁷ User Manual is not comprehensive and indicates that the user "should discover the working of Text⁸⁷ on

his/her particular hardware by trial and use . . . for any particular task." Text⁸⁷ embodies the latest trends in wordprocessor design which make use of greater RAM and on-line memory and incorporates the following features:

- * Control of page layout and text dimensions in absolute units (millimeters or inches)

- * The ability to mix characters with different sizes and typefaces on each line

- * Full use of printer features for variable line-spacing, columnization, micro-justification, etc., using dedicated printer driver files

- * The entire document is held in RAM

- * Greatly accelerated operations



IS THE QL EXTINCT?

We don't think so!

We want you to know that we are STILL stocking and supporting the QL in every way we can! If you want a NEW or USED QL, s/w or h/w to add to your system or just need some advice - RMG will do all we can to help you. There are a LOT of NEW and EXCITING products coming out every month to add to your computing pleasure on your QL. Read about them in QL WORLD USER and TIME DESIGNS - THEN CALL RMG FOR PRICE AND AVAILABILITY. If we don't know - we'll find out! JUST CHECK OUT THESE SPECIALS=====>>



RMG ENTERPRISES

1419 1/2 7TH STREET
OREGON CITY, OREGON 97045

503/655-7484 * NOON-10 TUE-SAT



HERE ARE A COUPLE OF SPECIALS

| | |
|--|----------------|
| QL PACKAGE COMPLETE-30 DAY WARRANTEE | \$149 PP* |
| QL PACKAGE-USED 15 DAY WARRANTEE | \$110 PP* |
| MIRACLE CENT. PRINTER I/F | \$ 48 PP* |
| EW TRIVIA QLUÉ GAME REG. \$19.95----- | \$ 15 PP* |
| FLACHBACK REG. \$39.95----- | \$ 37 PP* |
| SPEEDSCREEN REG. \$39.95----- | \$ 37 PP* |
| 1 ONLY! SUPER TOOLKIT II EPROM CART--- | \$ 55 PP* |
| 1 ONLY! QFLASH EPROM CART----- | \$ 33 PP* |
| 1 ONLY! CONCEPT 3D----- | \$ 28 PP* |
| 2 ONLY! GRAM (USED)----- | EACH-\$ 33 PP* |

*POSTPAID CONTINENTAL US ONLY-CALL IF OUTSIDE
Many more great buys! Get our catalog and see!

In order to use **Text⁸⁷**'s advances to full effect, one must become familiar with several new concepts underlying its design and change some old wordprocessing habits.

Making a Working Copy

Text⁸⁷ will not run from the master disk or cartridge; one of a number of printer-driver files must be copied to a program disk as **driver_P87**, one of three essential files (the others **text87** and **default11_F87**, the program itself and a default fount file, respectively).

Text⁸⁷ is not copy protected. Use any "copy" command available to transfer files. Other **_P87** suffixed files need not be copied. (See Section VII of the manual for printer driver data.) **_F87** files are screen display founts; copy needed one to the working copy program disk or a second Microdrive cartridge. **_I87** files are source files used to modify various printer drivers; the use of an assembler is required. **Founts_A87** is a list of founts available and should be copied to the program disk/cartridge. **Recon_bas** and **Key_bas** are SuperBASIC files used to configure **Text⁸⁷**: the former to specify program and file media to be used, the latter to alter the keyboard layout (from QWERTY to AZERTY, etc., as desired, similar to QL Quill's translate options).

Text⁸⁷ Operations

Text⁸⁷ is an EXECutable program, that is, it may be executed by the command EXEC (or EX with Toolkit 2):

```
EXEC (or EX) flp1_text87
```

(A suggested--and modifiable--BOOT file is included in the User Manual to optimize the screen presentation.)

If the minimum memory required (256K) is available, the text window will appear with the cursor flashing in the lower left corner of the screen--hold the CTRL key down while pressing the C key to activate **Text⁸⁷** and move the cursor to the top left of the text window. Important immediate commands are as follows: key F4 to "redraw" the text window whenever desired; key F3 to produce the MAIN MENU below the text window; key ESC to return to the text window.

Cursor movement and deletion commands are well documented: the cursor may be moved in the normal and a number of accelerated ways to various parts of the document; deletion of letters, words, parts of lines, and entire lines may easily be made (most delete commands do not reformat an amended paragraph).

SHIFT F4 inserts a new fount at the cursor position and SHIFT F5 INSERTS a new "line guide" on the following line. ENTER functions as a carriage return, CTRL SHIFT F4 as a page number command, and three types of "break the line" command are available. Other marker symbols are also used. ESC aborts the current level of a menu-driven command.

Text⁸⁷ is menu-intensive: keying F3 produces the MAIN MENU, only one of many menus and sub-menus. ESC returns operations to the text window. Keying the first letter of each menu item (or ENTER for the first item in a menu) then produces either a prompt or a sub-menu, used in the same way. In the version tested, some menu items were present but not yet implemented. When a prompt requests a number, the range of suitable numbers is displayed; "intelligent" replies or parts of replies are usually given to prompts. ESC returns operation to the previous level.

At start-up, the following data is displayed below the text window:

```
Text:      Words:      Line:      Frame:
```

Keying F3 produces the following MAIN MENU, the entry point to the Extended Command system:

```
Alpha* Block Context Doc* Files Goto
```

Keying the first letter of each option executes the command sequence producing an action, a prompt, or a sub-menu.

Once executed, **Text⁸⁷** makes no further demands for extra memory from the QL, but every time a file is loaded or saved, or a printout made, the program attempts to open a channel through the QL to perform the operation. **Text⁸⁷** may be used to good effect with TOOLKIT II, and suggestions for this are given in the User Manual.

The user may select which screen display fount (three colors, plain or underlined) represents a "printype." A printype is a unique combination of a printer typeface and one of the forms in which may be printed on your printer. Each printer driver included provides a large selection of printypes, each of which may be selected and uniquely represented on the screen.

Text on each line is formatted according to a defined "ruler" which governs margins, tabs, indentations, justification and scale. Up to sixteen rulers may be defined and later selected from.

The basic implication of using **Text⁸⁷** is the potentiality of using a single program as word processor and no-nonsense desktop publisher. This is the strength of **Text⁸⁷** and makes it worth the expense of purchase and learning a new system.

Text⁸⁷ Extended Command Hierarchy

The table on the next page illustrates the extended command hierarchy. Space precludes a thorough definition of command functions and recommended procedures in one article, so this will be continued in the next issue of Time Designs.

If you don't want to wait, you may order **Text⁸⁷** directly from **Software87**, 33 Savernake Road, London NW3 2JU, United Kingdom. Airmail price is \$75, payable by traveler's check, international GIRO postal money order, or other check directly payable at a U.K. bank; add about \$8.50 for checks not so payable. **Founted⁸⁷** is a companion font editor available at \$15.

Text⁷ Extended Command Hierarchy

1. Alpha* - selects normal/additional character set
2. Block - highlights part of text for various operations
 - a. Copy - copies block to cursor position
 - b. Delete - deletes block
 - c. Goto - moves cursor to first line of block
 - d. Move - moves block to cursor position
 - e. Ruler - changes the "ruler" format of the block to one selected by the Ruler option of MAIN MENU (a ruler designates the margins, indentation, and tabs used for a section of text)
 - f. Type - changes the "printype" of the block to one selected by the Type option of MAIN MENU (a printype is a combination of type size and font design)
 - g. Unset - deactivates and removes highlight from block
3. Context - sets all parameters that are not part of a given document's format
 - a. Attach:
 - 1) Select - selects font and color to represent a printype (typefaces and options supported by the printer driver)
 - 2) View - displays available printypes and the fonts and colors which represent them
 - b. Driver:
 - 1) Load - loads another printer driver file
 - 2) Save - saves current printer driver file to retain info entered using Attach option
 - c. Founts - loads extra founts
 - 1) Multiple - loads all founts listed in the founts_AB7 file
 - 2) Single - loads a single specified fount
 - d. Paras - modifies certain paragraph parameters
 - 1) Indent - toggles "auto indent mode" on or off (ENTER moves cursor to first TAB position on next line of text)
 - 2) Decimal TAB Character - allows definition of decimal point character on which numbers will be aligned at the decimal TAB position
 - 3) Length Unit - selects unit of length used for margins, tabs, page layout, etc. as millimeters or 1/6" or 1/10"
 - 4) Memory Size - sets amount of memory to be allocated to Text⁷ at start-up
 - 5) Storage & Printing - sets certain parameters for storing and using text and founts for printing operations
 - e. Load - loads a _C87 (screen and page) parameter file
 - f. Save - saves current parameters to a _C87; if file is named configure_C87, it loads automatically
 - g. Window - adjusts size and location of text window
 - h. View:
 - 1) Compress - toggles screen representation of line-spacing on and off

- 2) Inverse - toggles screen paper to black or white
- 3) Scale - Selects scale of pixel vs. page length
4. Doc - selects section of text to be edited; not yet implemented
5. Files - selects all text file operations, that is, Save, Load, Export, Import (QL Quill _doc files may be loaded)
6. Goto - accelerates cursor movement to top, bottom, or specified line of text
7. Layout - sets layout of columns, header, and footer on page and page size

THE MOST COMPREHENSIVE RESOURCE FOR THE SINCLAIR QL. GET YOUR COPY TODAY!!

More and more QL owners are discovering the excellent new book by Mike de Sosa — **TAKING THE QUANTUM LEAP: The Last Word On The Sinclair QL.**

This 280 page book is chock full of useful programs and original programming examples. Chapters on using the bundled software and a look at the latest hardware and software releases. Written for both the novice and more advanced users. Priced less than most software packages and nearly two pounds of information!!

\$26 (USA).

Exclusively available from:

TIME DESIGNS

29772 Hult Road, Colton, Oregon, 97017, USA. Telephone (503) 824-2658.

VISA and MASTERCARD accepted.

Software for the QL that really works

- MAILBAG** An address database you won't believe. Labels, Rotary files, Zip sort, tickler file, many auto features, & more...256K
- TAX-I-QL** Spreadsheet for IRS tax returns.....384K
- QLANDLORD** Manage 99 buildings or units. Do Sched E..256K

\$19.95 ea pp on 5 1/4" DSQD
(+\$2.00 on microcartridge)

AND The most comprehensive list of independent North American software for the QL.

Agents for ZX/TS SiriusWare
4K Wordprocessor with
TS 2040 lower case printer driver

Orders, Catalogues & Dealer info

EMSoft

P.O. Box 8763, Boston, MA 02114
(617) 889-0830

VISA/MC ok

FULL COLOR SCREEN DUMPS for the 2068!! A new ver. of "COLOR COPY" for OKIMATE 20 printer, IBM Plug 'n Print cart., & AERCO/OLIGER par. printer I/F is avail. for \$8.95 ppd Write to: John McMichael, 1710 Palmer Dr., Laramie, WY 82070, or call (307) 742-4530 evenings.

WANTED: VU-FILE in T.C.C. Cartridge (Timex) format for the TS2068. Will pay reasonable amount plus postage. Jerry Campbell, 8717 NE 138th, Kirkland, WA 98034.

MAILING LIST FOR SALE: TIMEX AND SINCLAIR users who attended '88 Northwest Computer Show. Complete for only \$5.00 ppd. Rod Gowen, 1419 1/2 7th Street, Oregon City, Oregon 97045.

SPECIAL LIMITED TIME OFFER: With proof of RENEWAL/NEW SUB. to TIME DESIGNS, get SEVEN issues of SINCUS NEWS (T/S User Group Newsletter) for only \$8. Thats an extra issue free! Offer expires 12/31/88. SINCUS NEWS, 1229 Rhodes Rd., Johnson City, NY 13790.

FOR SALE: TS2068 W/RGB OUTPUT, A&J Microdrive, Microwafers, Alphacom 32 printer, software and books. Call or send for prices and list: Steve Kershaw, 547 S. Church, Virden, IL 62690; (217) 965-3537.

FOR SALE OR TRADE: ELECTRONIC TEST EQUIPMENT--electronic books. Send SASE for list. WANTED: LARKEN or OLIGER disk system for TS2068. W.E. Powden Sr., RR#1 Box 364, Bridgeport, IL 62417.

TAPES FOR TS1000+16K or TS1500. Automatically generate tables of monthly posted daily compounded interest tables, of fixed rate mortgages, of adjustable rate mortgages, and of annuities. Available for just \$10 (U.S) each from: Edwin N. Phillips, 540 Marilea Court, Orange City, FL 32763.

SHOW THOSE ROAD HOGS ON THE INTERSTATE how you feel!! "STILL ALIVE WITH UNCLE CLIVE", vinyl bumper sticker. \$2.00 + legal size SASE. T. Simon, 615 School Ave., Cuyahoga Falls, OH 44221.

The Classified

FREE ADS FOR SUBSCRIBERS

GOT 2068 COLOR INTERFERENCE on your MONOCHROME MONITOR?? Get a "Color Killer Kit" for \$24. OR send BARE 2068 to same address for modification - \$45. Make payable to: Randy Kopisch, 1315 Choctaw, Alva, OK 73717.

USER GROUP NEWSLETTER: QZX, about the amateur radio uses of Sinclair computers. \$15 per year. Sample issue for SASE (with \$.45 postage) to: K5XY, 2025 O'Donnell, Las Cruces, NM 88001.

FOR SALE: (2) 2068's; ZEBRA 3-PART Disk Drive System, disks, mag on cassette from Eng., programs, modem, books. SASE for complete list & prices. R. Zuch, 120 Holly Rd., Pine Knoll Shores, NC 28557.

FOR SALE: WESTRIDGE MODEM \$30.00, or will swap for AERCO Centronics Interface for TS2068. Contact D.H. Berry, 1328 Springlite Way, Orlando, FL 32817.

FOR SALE: Z88 COMPUTER in original package with vinyl carry case and 32K ROM pack - \$375. Edward Snow, 2136 Churchill Downs Circle, Orlando, FL 32825; phone (407) 380-5124.

WANTED! USED OS-64 CARTRIDGE and used SPECTRUM EMULATOR Cart. Phone (503) 669-0639. Gaylen W. Bench, Gresham, Oregon.

WANTED: PHILADELPHIA, PA - AREA users of T/S computers, to form our own users group either as an independent SIG or a sub-SIG of Phila. Area Computer Society. Contact Mike Finn, 4537 Almond St., Philadelphia, PA 19137.

FOR SALE: TS1000-TS2068-QL-SPECTRUM hardware and software. For list send S.A.S.E. to: R.J. Burt, RR#5 Box 157, Belleville, Ontario, Canada, K8N-4Z5.

FOR SALE: (2) QLs, numerous books, hardware, software. For list & prices contact: R.W. Swafford, 2011 Hoover St., Lawton, OK 73507; or call (405) 357-0589 after 4 PM CST.

FOR SALE: SINCLAIR QL...needs some help. Centronics Printer Interface, two manuals, two power supplies, software including QL Entrepreneur. All for \$90 including shipping. Ted Sobel, 219 White Church Road, Brooktondale, NY 14817; (607) 539-7920.

FOR SALE: (2) 2068's; OLIGER DISK Drive (DD40) complete; A&J Microdrive, complete-all like new. Books, original programs, micro-cassettes. (205) 859-2944, Huntsville, AL; Lionel Barthelemy.

WANTED: NEW OR USED WAFERS FOR A&J Microdrive for TS1000. C.L. Hamilton, 4004-27A St., Vernon, B.C., Canada, V1T-4Z2; phone (604) 542-1095.

SINCLAIR SHAREWARE DISK FILE EXCHANGE. For info and sample newsletter, send \$1.00 (Check to "Sinclink", stamps or cash). SINCLINK, 6675 Clifford Dr., Cupertino, CA 95014.

WANTED: "EXPANDABLE ZX80 + ZX81" by J. Jarrett, ZWEST back issues, Big Ears Speech Recognition System by Sinclair Place. Write to: Van Vangor, 346C Retreat Rd., Island Falls, ME 04747.

HARDBACK SOFTWARE: 17 TITLES!! Fighter Pilot, Word Processor, Flight cart., modem program, misc. 2068 cassettes, original material. All 50% below retail. Free Shipping: phone (512) 839-4516.

FOR SALE: (2) QL's (new), TS2068 hardware and software (new). Legal size SASE for list. WANTED: Timex Disk Drive System "twister", 2068 business software on 3" disk. Stan Light, PO Box 13, Ellenton, FL 34222; phone (813) 746-0478.

Do you have some equipment or a program that you would like to sell? Looking for something hard to find? Place an ad in **THE CLASSIFIEDS!** Subscribers can place one free personal ad in each issue. Ad size is 32 Col. wide (like 2040 paper) and maximum of six lines. For additional lines - \$3 each. **NON-SUBSCRIBERS** and **DEALERS:** \$4 a line. **DEADLINE FOR ALL CLASSIFIED ADS:** Two weeks before publication date. Mail your ad to: **TIME DESIGNS MAGAZINE, The Classifieds Dept., 29722 Hult Rd., Colton, Oregon 97017.**

2068 Graphics Designer Series
Banner Designer
Greeting Card Designer
Sign Designer

All 3 programs for just \$29.95

Zebra's 2068 Graphics Designer Series includes three programs that let you create Greeting Cards, Signs, and Banners. Each program allows you to mix text and pictures in your creations. Plus, all programs include picture libraries as well as graphics editors so that you can create your own pictures to add to the picture libraries. Great for birthdays, holidays and business too!

Interfaces supported: AERCO, Tasman B&C, A&J. Printers supported: Epson RX/FX and compatibles, Star 10X/SG10/NX10, Memotech DMX80, Panasonic 1090, Prowriter, Seikosha GP250, Gorilla Banana, Legend 808. Order Cat# GS03 \$29.95

Signs,
Banners, and
Greeting Cards
made with the
2068 Graphics
Designers



3 New Fantastic Picture Collections
for use with Zebra's Graphics Designer Series
and Lemke's Pixel Print

These pictures were created for us by very talented graphics artists. Each of the three collections consists of 120 pictures supplied as 4 tapes containing 30 pictures each. Some samples from each collection are shown below.

- Picture Collection #1 4 tapes, 30 pictures per tape.
Sports, America, Party, Office #GS11 \$19.95
- Picture Collection #2 4 tapes, 30 pictures per tape.
Animals, Nature, Religion, Travel #GS12 \$19.95
- Picture Collection #3 4 tapes, 30 pictures per tape.
Holiday Collection including Christmas, Chanukah, Thanksgiving,
New Year's, Easter, Halloween, etc. Order #GS13 \$19.95

**Samples From
Picture Collection #1**



America



Sports



Party



Office

**Samples From
Picture Collection #2**



Animals

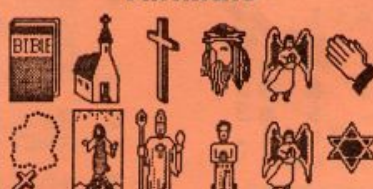

Religion



Nature



Travel

**Samples From
Picture Collection #3**



Christmas



Easter & Thanksgiving



Jewish Holidays



New Year's, July 4th, Halloween,
Parades, St. Paty's & Valentines

Zebra Systems, Inc.
78-06 Jamaica Ave.
Woodhaven, NY 11421
(718) 296-2385

Ordering Instructions: All orders add \$3.00 Shipping and Handling. UPS COD add \$3.00. VISA/MC Accepted. NY residents add sales tax.

Pixel Print PLUS!
THE DESKTOP PUBLISHER
by Lenke Software



**What's the PLUS?
PERFORMANCE!**



Checkout these SPECS:

- 1) WYSIWYG (What You See Is What You Get!)

 Create your text on the screen... as easy as typing!
 LOAD graphics... Load ICONs...
 Import TASWORD text via the TASWORD conversion utility.
- 2) AUTOMATIC and MANUAL line and character adjustments.
- 3) RESTORE FONT (after using the BOLD/MODERN/ITALIC modifiers).
- 4) KEEP/UNDO/SAVE/LOAD/LOAD ICON
 LOAD SCREEN#/SAVE SCREEN#
 WIDE/HIGH/CLS/SCROLL SPEED
- 5) OVER/INVERSE/CAPS LOCK
 UP TO 16 POINT FONTS
 (font package in development)
- 6) COPY/ERASE/INSERT/DELETE/NEW
- 7) AERCO/TASMAN A&B/A&J CPI
- 8) IBM/EPSON/PROWRITER type printers.

Pixel Print **PLUS!** has all of the features found in v2.0, it is 100% compatible with the Pixel Print **ICON #1 & #2** packages, **FONTS #1, #2, & #3** as well as the **TASWORD Util.** and your Pixel Print files!!



Lenke Software
2144 White Oak
Wichita, Ks.
67207

| | |
|---------------------------------|---------|
| PIXEL PRINT PLUS!.... | \$19.95 |
| TASWORD TEXT CONV.... | \$19.95 |
| ICON PACKAGE #1..... | \$19.95 |
| ICON LIBRARY #2..... | \$14.95 |
| FONT PACKAGE #1..... | \$19.95 |
| FONT LIBRARY #2..... | \$14.95 |
| FONT LIBRARY #3..... | \$19.95 |
| 1989 PERSONAL CALENDAR | \$19.95 |
| MASTHEAD PACKAGE #2.. | \$14.95 |
| 16 POINT FONTS..... | \$14.95 |
| MEGA FONTS..... | \$14.95 |
| PIXEL SKETCH v2.0.... | \$19.95 |
| CHECKBOOK BUDGET MASTER..... | \$19.95 |

Pixel Print Professional



AERCO DISK VERSION!

- * Pixel Print Plus v3.2
- * Create up to 20 page documents
- * Print a complete Doc header, left, & right
(no more printer adjustments!)
- * Uses bank-switching to print left and right columns together
- * Print multiple Copies!
- * Newsletter Format or
- * 64 Column Letter Format

NOTE: printers must be capable of 72 to 90 Dots per inch (576 to 720 dots per line) bit image Graphics!!!

- * Automated Printer Customizing
- * 5500 diskette (OR AUTO-SAVE TAPE)
- * only \$29.95 ppd. (ORDER NOW!)

OLIGER DISK VERSION!

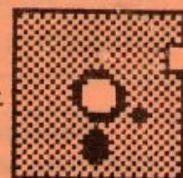

- * Same as the AERCO version above except for use with the **Oliger Disk Interface** (5500 Disk)
- * Requires a minimum of 32K RAM expansion... (see the 32K RAM Cartridge below!)
- * only \$29.95 ppd. (ORDER NOW!)

LARKEN DISK VERSION!

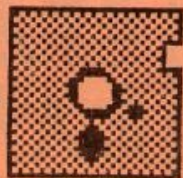

- * Same as the AERCO version above except for use with the **LARKEN Disk Interface** (5500 Disk)
- * Requires a minimum of 64K RAM DISK memory expansion.
- * only \$29.95 ppd. (ORDER NOW!)

Pixel Print Professional

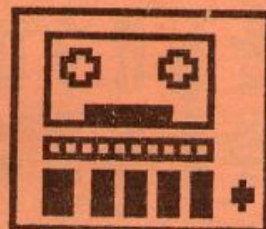

For CASSETTE & MICRODRIVE

* Same as Aerco except for use with Tapes...

NOTE: Specify either TAPE or MICRODRIVE...

- * Requires a minimum of 32K RAM expansion... (see the 32K RAM Cartridge below!)
- * only \$29.95 ppd. (ORDER NOW!)

32K RAM CARTRIDGE

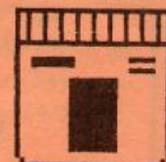

- * 32K Volatile Memory
- * Fits into the TS-2068 Cartridge Dock
 only \$44.00 with the purchase of the DTP above.
 (\$47.95 if purchased separately)